

SYLLABUS

ENGINEERING MATHEMATICS-II

Subject Code: 15MAT21

Hours/Week: 04

Total Hours: 50

IA Marks: 20

Exam. Hours: 03

Exam Marks: 80

Objectives:

To enable students to apply knowledge of Mathematics in various engineering fields by making them to learn the following

- Ordinary differential equations
- Partial differential equations
- Double and triple integration
- Laplace transform

Module – 1

Differential equations-1:

Linear differential equations with constant coefficients: Solutions of second and higher order differential equations - inverse differential operator method, method of undetermined coefficients and method of variation of parameters. **10 hrs**

Module – 2

Differential equations-2:

Solutions of simultaneous differential equations of first order.

Linear differential equations with variable coefficients: Solution of Cauchy's and Legendre's linear differential equations.

Nonlinear differential equations - Equations solvable for p, equations solvable for y, equations solvable for x, general and singular solutions, Clairaut's equations and equations reducible to Clairaut's form.

10 hrs

Module – 3**Partial Differential equations:**

Formulation of PDE by elimination of arbitrary constants/functions, solution of non-homogeneous PDE by direct integration, solution of homogeneous PDE involving derivative with respect to one independent variable only.

Derivation of one dimensional heat and wave equations and their solutions by variable separable method. 10hrs

Module – 4**Integral Calculus:**

Double and triple integrals: Evaluation of double and triple integrals. Evaluation of double integrals by changing the order of integration and changing into polar coordinates.

Application of double and triple integrals to find area and volume.

Beta and Gamma functions: definitions, Relation between beta and gamma functions and simple problems. 10hrs

Module –5**Laplace Transform:**

Definition and Laplace transforms of elementary functions. Laplace transforms of

$e^{at} f(t)$, $t^n f(t)$ and $\frac{f(t)}{t}$ (without proof), periodic functions, unit-step function - problems

Inverse Laplace Transform

Inverse Laplace Transform - problems, Convolution theorem to find the inverse Laplace transforms (without proof) and problems, solution of linear differential equations using Laplace Transforms. 10hrs

Course Outcomes:

On completion of this course, students are able to,

- Use ordinary differential equations to model engineering phenomena such as electrical circuits, forced oscillation of mass spring and elementary heat transfer.
- Use partial differential equations to model problems in fluid mechanics, electromagnetic theory and heat transfer.
- Evaluate double and triple integrals to find area, volume, mass and moment of inertia of plane and solid region.
- Use curl and divergence of a vector function in three dimensions, as well as apply the Green's Theorem, Divergence Theorem and Stokes' theorem in various applications like electricity, magnetism and fluid flow.
- Use Laplace transforms to determine general or complete solutions to linear ODE.

INDEX SHEET

- **Module1: Differential Equations –I.....5-30**
- **Module2: Differential Equations –II.....31-51**
- **Module3: Partial Differential Equations.....52-72**
- **Module4: Integral Calculus.....73-108**
- **Module5: Laplace Transforms.....109-160**

MODULE - 1

DIFFERENTIAL EQUATIONS –I

INTRODUCTION:

We have studied methods of solving ordinary differential equations of first order and first degree, in chapter-7 (Ist semester). In this chapter, we study differential equations of second and higher orders. Differential equations of second order arise very often in physical problems, especially in connection with mechanical vibrations and electric circuits.

LINEAR DIFFERENTIAL EQUATIONS OF SECOND AND HIGHER ORDER WITH CONSTANT COEFFICIENTS

A differential equation of the form

$$\frac{d^n y}{dx^n} + a_1 \frac{d^{n-1} y}{dx^{n-1}} + a_2 \frac{d^{n-2} y}{dx^{n-2}} + \dots + a_n y = X \quad \dots(1)$$

where X is a function of x and a_1, a_2, \dots, a_n are constants is called a linear differential equation of n^{th} order with constant coefficients. Since the highest order of the derivative appearing in (1) is n , it is called a differential equation of n^{th} order and it is called linear.

Using the familiar notation of differential operators:

$$D = \frac{d}{dx}, \quad D^2 = \frac{d^2}{dx^2}, \quad D^3 = \frac{d^3}{dx^3}, \dots, \quad D^n = \frac{d^n}{dx^n}$$

Then (1) can be written in the form

$$\{D^n + a_1 D^{n-1} + a_2 D^{n-2} + \dots + a_n\} y = X$$

i.e., $f(D) y = X \quad \dots(2)$

where $f(D) = D^n + a_1 D^{n-1} + a_2 D^{n-2} + \dots + a_n$.

Here $f(D)$ is a polynomial of degree n in D

If $x = 0$, the equation

$$f(D) y = 0$$

is called a homogeneous equation.

If $x \neq 0$ then the Eqn. (2) is called a non-homogeneous equation.

SOLUTION OF A HOMOGENEOUS SECOND ORDER LINEAR DIFFERENTIAL EQUATION

We consider the homogeneous equation

$$\frac{d^2y}{dx^2} + p \frac{dy}{dx} + qy = 0$$

where p and q are constants

$$(D^2 + pD + q) y = 0$$

The Auxiliary equations (A.E.) put $D = m$

$$m^2 + pm + q = 0$$

Eqn. (3) is called auxiliary equation (A.E.) or characteristic equation of the D.E. eqn. (1) quadratic in m , will have two roots in general. There are three cases.

Case (i): Roots are real and distinct

The roots are real and distinct, say m_1 and m_2 i.e., $m_1 \neq m_2$

Hence, the general solution of eqn. (1) is

$$y = C_1 e^{m_1 x} + C_2 e^{m_2 x}$$

where C_1 and C_2 are arbitrary constant.

Case (ii): Roots are equal

The roots are equal i.e., $m_1 = m_2 = m$.

Hence, the general solution of eqn. (1) is

$$y = (C_1 + C_2 x) e^{mx}$$

where C_1 and C_2 are arbitrary constant.

Case (iii): Roots are complex

The Roots are complex, say $\alpha \pm i\beta$

Hence, the general solution is

$$y = e^{\alpha x} (C_1 \cos \beta x + C_2 \sin \beta x)$$

where C_1 and C_2 are arbitrary constants.

Note. Complementary Function (C.F.) which itself is the general solution of the D.E.

1. Solve $\frac{d^2y}{dx^2} - 5 \frac{dy}{dx} + 6y = 0$.

Solution. Given equation is $(D^2 - 5D + 6) y = 0$

A.E. is $m^2 - 5m + 6 = 0$

i.e., $(m - 2)(m - 3) = 0$

i.e., $m = 2, 3$

$\therefore m_1 = 2, m_2 = 3$

\therefore The roots are real and distinct.

∴ The general solution of the equation is

$$y = C_1 e^{2x} + C_2 e^{-3x}.$$

2. Solve $\frac{d^3 y}{dx^3} - \frac{d^2 y}{dx^2} - 4 \frac{dy}{dx} + 4y = 0.$

Solution. Given equation is $(D^3 - D^2 - 4D + 4) y$

A.E. is $m^3 - m^2 - 4m + 4 = 0$

$$m^2(m - 1) - 4(m - 1) = 0$$

$$(m - 1)(m^2 - 4) = 0$$

$$m = 1, m = \pm 2$$

$$m_1 = 1, m_2 = 2, m_3 = -2$$

∴ The general solution of the given equation is

$$y = C_1 e^x + C_2 e^{2x} + C_3 e^{-2x}$$

3. Solve $\frac{d^2 y}{dx^2} - \frac{dy}{dx} - 6y = 0.$

Solution. The D.E. can be written as

$$(D^2 - D - 6) y = 0$$

A.E. is $m^2 - m - 6 = 0$

$$\therefore (m - 3)(m + 2) = 0$$

$$\therefore m = 3, -2$$

∴ The general solution is

$$y = C_1 e^{3x} + C_2 e^{-2x}.$$

4. Solve $\frac{d^2 y}{dx^2} + 8 \frac{dy}{dx} + 16y = 0.$

Solution. The D.E. can be written as

$$(D^2 + 8D + 16) y = 0$$

A.E. is $m^2 + 8m + 16 = 0$

$$\therefore (m + 4)^2 = 0$$

$$(m + 4)(m + 4) = 0$$

$$m = -4, -4$$

∴ The general solution is

$$y = (C_1 + C_2 x) e^{-4x}.$$

5. Solve $\frac{d^2 y}{dx^2} + w^2 y = 0.$

Solution. Equation can be written as

$$(D^2 + w^2) y = 0$$

A.E. is $m^2 + w^2 = 0$

$$m^2 = -w^2 = w^2 i^2 \quad (i^2 = -1)$$

$$m = \pm w i$$

This is the form $\alpha \pm i\beta$ where $\alpha = 0$, $\beta = w$.

\therefore The general solution is

$$y = e^{0t} (C_1 \cos wt + C_2 \sin wt)$$

$$\therefore y = C_1 \cos wt + C_2 \sin wt.$$

6. Solve $\frac{d^2 y}{dx^2} + 4 \frac{dy}{dx} + 13y = 0$.

Solution. The equation can be written as

$$(D^2 + 4D + 13)y = 0$$

A.E. is $m^2 + 4m + 13 = 0$

$$m = \frac{-4 \pm \sqrt{16 - 52}}{2}$$

$$= -2 \pm 3i \quad (\text{of the form } \alpha \pm i\beta)$$

\therefore The general solution is

$$y = e^{-2x} (C_1 \cos 3x + C_2 \sin 3x).$$

INVERSE DIFFERENTIAL OPERATOR AND PARTICULAR INTEGRAL

Consider a differential equation

$$f(D)y = x \quad \dots(1)$$

Define $\frac{1}{f(D)}$ such that

$$f(D)\left\{\frac{1}{f(D)}\right\}x = x \quad \dots(2)$$

Here $f(D)$ is called the inverse differential operator. Hence from Eqn. (1), we obtain

$$y = \frac{1}{f(D)}x \quad \dots(3)$$

Since this satisfies the Eqn. (1) hence the particular integral of Eqn. (1) is given by Eqn. (3)

Thus, particular Integral (P.I.) = $\frac{1}{f(D)}x$

The inverse differential operator $\frac{1}{f(D)}$ is linear.

i.e., $\frac{1}{f(D)}\{ax_1 + bx_2\} = a \frac{1}{f(D)}x_1 + b \frac{1}{f(D)}x_2$

where a, b are constants and x_1 and x_2 are some functions of x .

SPECIAL FORMS OF THE PARTICULAR INTEGRAL

Type 1: P.I. of the form $\frac{e^{ax}}{f(D)}$

We have the equation $f(D) y = e^{ax}$

Let $f(D) = D^2 + a_1 D + a_2$

We have $D(e^{ax}) = a e^{ax}$, $D^2(e^{ax}) = a^2 e^{ax}$ and so on.

$$\begin{aligned} \therefore f(D) e^{ax} &= (D^2 + a_1 D + a_2) e^{ax} \\ &= a^2 e^{ax} + a_1 \cdot a e^{ax} + a_2 e^{ax} \\ &= (a^2 + a_1 \cdot a + a_2) e^{ax} = f(a) e^{ax} \end{aligned}$$

Thus $f(D) e^{ax} = f(a) e^{ax}$

Operating with $\frac{1}{f(D)}$ on both sides

$$\text{We get, } e^{ax} = f(a) \cdot \frac{1}{f(D)} \cdot e^{ax}$$

$$\text{or P.I.} = \frac{1}{f(D)} e^{ax} = \frac{e^{ax}}{f(D)}$$

In particular if $f(D) = D - a$, then using the general formula.

$$\text{We get, } \frac{1}{D-a} e^{ax} = \frac{e^{ax}}{(D-a)\phi(D)} = \frac{1}{D-a} \cdot \frac{e^{ax}}{\phi(a)}$$

$$\text{i.e., } \frac{e^{ax}}{f(D)} = \frac{1}{\phi(a)} e^{ax} \int 1 \cdot dx = \frac{1}{\phi(a)} \cdot x e^{ax} \quad \dots(1)$$

$$\therefore f(a) = 0 + \phi(a)$$

$$\text{or } f(a) = \phi(a)$$

Thus, Eqn. (1) becomes

$$\frac{e^{ax}}{f(D)} = x \cdot \frac{e^{ax}}{f'(D)}$$

$$\text{where } f(a) = 0$$

$$\text{and } f'(a) \neq 0$$

This result can be extended further also if

$$f(a) = 0, \frac{e^{ax}}{f(D)} = x^2 \cdot \frac{e^{ax}}{f''(a)} \text{ and so on.}$$

Type 2: P.I. of the form $\frac{\sin ax}{f(D)}, \frac{\cos ax}{f(D)}$

We have $D(\sin ax) = a \cos ax$

$$\begin{aligned}
 D^2 (\sin ax) &= -a^2 \sin ax \\
 D^3 (\sin ax) &= -a^3 \cos ax \\
 D^4 (\sin ax) &= a^4 \sin ax \\
 &= (-a^2)^2 \sin ax \text{ and so on.}
 \end{aligned}$$

Therefore, if $f(D^2)$ is a rational integral function of D^2 then $f(D^2) \sin ax = f(-a^2) \sin ax$.

$$\text{Hence } \frac{1}{f(D^2)} \{f(D^2) \sin ax\} = \frac{1}{f(D^2)} f(-a^2) \sin ax$$

$$\text{i.e., } \sin ax = f(-a^2) \frac{1}{f(D^2)} \sin ax$$

$$\text{i.e., } \frac{1}{f(D^2)} \sin ax = \frac{\sin ax}{f(-a^2)}$$

$$\text{Provided } f(-a^2) \neq 0 \quad \dots(1)$$

Similarly, we can prove that

$$\frac{1}{f(D^2)} \cos ax = \frac{\cos ax}{f(-a^2)}$$

$$\text{if } f(-a^2) \neq 0$$

$$\text{In general, } \frac{1}{f(D^2)} \cos ax = \frac{\cos ax}{f(-a^2)}$$

$$\text{if } f(-a^2) \neq 0 \quad \dots(2)$$

$$\frac{1}{f(D^2)} \sin(ax+b) = \frac{1}{f(-a^2)} \sin(ax+b)$$

$$\text{and } \frac{1}{f(D^2)} \cos(ax+b) = \frac{1}{f(-a^2)} \cos(ax+b)$$

These formula can be easily remembered as follows.

$$\frac{1}{D^2 + a^2} \sin ax = \frac{x}{2} \int \sin ax \, dx = \frac{-x}{2a} \cos ax$$

$$\frac{1}{D^2 + a^2} \cos ax = \frac{x}{2} \int \cos ax \, dx = \frac{x}{2a} \sin ax.$$

Type 3: P.I. of the form $\frac{\phi(x)}{f(D)}$ where $\phi(x)$ is a polynomial in x , we seeking the polynomial Eqn. as the particular solution of

$$f(D)y = \phi(x)$$

where

$$\phi(x) = a_0 x^n + a_1 x^{n-1} + \dots + a_{n-1} x + a_n$$

Hence P.I. is found by divisor. By writing $\phi(x)$ in descending powers of x and $f(D)$ in ascending powers of D . The division get completed without any remainder. The quotient so obtained in the process of division will be particular integral.

Type 4: P.I. of the form $\frac{e^{ax} V}{f(D)}$ where V is a function of x .

We shall prove that $\frac{1}{f(D)} e^{ax} V = e^{ax} \frac{1}{f(D+a)} V$.

$$\text{Consider } D(e^{ax} V) = e^{ax} DV + Va e^{ax} \\ = e^{ax} (D + a) V$$

$$\text{and } D^2(e^{ax} V) = e^{ax} D^2 V + a e^{ax} DV + a^2 e^{ax} V + a e^{ax} DV \\ = e^{ax} (D^2 V + 2a DV + a^2 V) \\ = e^{ax} (D + a)^2 V$$

Similarly, $D^3(e^{ax} V) = e^{ax} (D + a)^3 V$ and so on.

$$\therefore f(D) e^{ax} V = e^{ax} f(D + a) V \quad \dots(1)$$

$$\text{Let } f(D + a) V = U, \text{ so that } V = \frac{1}{f(D + a)} U$$

Hence (1) reduces to

$$f(D) e^{ax} \frac{1}{f(D + a)} U = e^{ax} U$$

Operating both sides by $\frac{1}{f(D)}$ we get,

$$e^{ax} \frac{1}{f(D + a)} U = \frac{1}{f(D)} e^{ax} U$$

$$\text{i.e., } \frac{1}{f(D)} e^{ax} U = e^{ax} \frac{1}{f(D + a)} U$$

Replacing U by V , we get the required result.

Type 5: P.I. of the form $\frac{xV}{f(D)}, \frac{x^n V}{f(D)}$ where V is a function of x .

By Leibniz's theorem, we have

$$D^n(xV) = x D^n V + n \cdot 1 D^{n-1} V \\ = x D^n V + \left\{ \frac{d}{dD} D^n \right\} V$$

$$\therefore f(D) xV = x f(D) V + f'(D) V \quad \dots(1)$$

Eqn. (1) reduces to

$$\frac{xV}{f(D)} = \left[x - \frac{f'(D)}{f(D)} \right] \frac{V}{f(D)} \quad \dots(2)$$

This is formula for finding the particular integral of the functions of the xV . By repeated application of this formula, we can find P.I. as $x^2 V, x^3 V \dots$.

Type 1

1. Solve $\frac{d^2 y}{dx^2} - 5 \frac{dy}{dx} + 6y = e^{5x}$.

Solution. We have

$$(D^2 - 5D + 6) y = e^{5x}$$

A.E. is $m^2 - 5m + 6 = 0$

i.e., $(m - 2)(m - 3) = 0$

$\Rightarrow m = 2, 3$

Hence the complementary function is

\therefore C.F. = $C_1 e^{2x} + C_2 e^{3x}$

Particular Integral (P.I.) is

$$\begin{aligned} \text{P.I.} &= \frac{1}{D^2 - 5D + 6} e^{5x} && (D \rightarrow 5) \\ &= \frac{1}{5^2 - 5 \times 5 + 6} e^{5x} = \frac{e^{5x}}{6}. \end{aligned}$$

\therefore The general solution is given by

$$\begin{aligned} y &= \text{C.F.} + \text{P.I.} \\ &= C_1 e^{2x} + C_2 e^{3x} + \frac{e^{5x}}{6}. \end{aligned}$$

2. Solve $\frac{d^2 y}{dx^2} - 3 \frac{dy}{dx} + 2y = 10e^{3x}$.

Solution. We have

$$(D^2 - 3D + 2) y = 10 e^{3x}$$

A.E. is $m^2 - 3m + 2 = 0$

i.e., $(m - 2)(m - 1) = 0$

$m = 2, 1$

C.F. = $C_1 e^{2x} + C_2 e^x$

$$\text{P.I.} = \frac{1}{D^2 - 3D + 2} 10e^{3x} \quad (D \rightarrow 3)$$

$$= \frac{1}{3^2 - 3 \times 3 + 2} 10e^{3x}$$

$$\text{P.I.} = \frac{10 e^{3x}}{2}$$

\therefore The general solution is

$$\begin{aligned} y &= \text{C.F.} + \text{P.I.} \\ &= C_1 e^{2x} + C_2 e^x + \frac{10 e^{3x}}{2}. \end{aligned}$$

3. Solve $\frac{d^2 y}{dx^2} - 4 \frac{dy}{dx} + 4y = e^{2x}$.

Solution. Given equation is

$$(D^2 - 4D + 4)y = e^{2x}$$

A.E. is $m^2 - 4m + 4 = 0$

i.e., $(m - 2)(m - 2) = 0$

$$m = 2, 2$$

$$\text{C.F.} = (C_1 + C_2) e^{2x}$$

$$\text{P.I.} = \frac{1}{D^2 - 4D + 4} e^{2x} \quad (D = 2)$$

$$= \frac{1}{2^2 - 4(2) + 4} e^{2x} \quad (Dr = 0)$$

Differentiate the denominator and multiply 'x'

$$= x \cdot \frac{1}{2D - 4} e^{2x} \quad (D \rightarrow 2)$$

$$= x \cdot \frac{1}{2(2) - 4} e^{2x} \quad (Dr = 0)$$

Again differentiate denominator and multiply 'x'

$$= x^2 \frac{1}{2} e^{2x}$$

$$\text{P.I.} = \frac{x^2 e^{2x}}{2}$$

$$y = \text{C.F.} + \text{P.I.} = (C_1 + C_2 x) e^{2x} + \frac{x^2 e^{2x}}{2}$$

Type2:

1. Solve $(D^3 + D^2 - D - 1) y = \cos 2x$.

Solution. The A.E. is

$$m^3 + m^2 - m - 1 = 0$$

$$\text{i.e., } m^2(m + 1) - 1(m + 1) = 0$$

$$(m + 1)(m^2 - 1) = 0$$

$$m = -1, m^2 = 1$$

$$m = -1, m = \pm 1$$

$$\therefore m = -1, -1, 1$$

$$\text{C.F.} = C_1 e^x + (C_2 + C_3 x) e^{-x}$$

$$\text{P.I.} = \frac{1}{D^3 + D^2 - D - 1} \cos 2x \quad (D^2 \rightarrow -2^2)$$

$$= \frac{1}{(D+1)(D^2-1)} \cos 2x$$

$$= \frac{1}{(D+1)(-2^2-1)} \cos 2x$$

$$= \frac{-1}{5} \frac{1}{D+1} \cos 2x$$

$$= \frac{-1}{5} \frac{\cos 2x}{D+1} \times \frac{D-1}{D-1}$$

$$= \frac{-1}{5} \frac{(D-1) \cos 2x}{D^2-1} \quad (D^2 \rightarrow -2^2)$$

$$= \frac{-1}{5} \left[\frac{-2 \sin 2x - \cos 2x}{-2^2-1} \right]$$

$$= \frac{-1}{25} (2 \sin 2x + \cos 2x)$$

\therefore The general solution is

$$y = \text{C.F.} + \text{P.I.}$$

$$= C_1 e^x + (C_2 + C_3 x) e^{-x} - \frac{1}{25} (2 \sin 2x + \cos 2x).$$

2. Solve $(D^2 + D + 1) y = \sin 2x$.

Solution. The A.E. is

$$m^2 + m + 1 = 0$$

$$i.e., \quad m = \frac{-1 \pm \sqrt{1-4}}{2} = \frac{-1 \pm \sqrt{3}i}{2}$$

Hence the C.F. is

$$C.F. = e^{-\frac{x}{2}} \left[C_1 \cos \frac{\sqrt{3}}{2} x + C_2 \sin \frac{\sqrt{3}}{2} x \right]$$

$$\begin{aligned} P.I. &= \frac{1}{D^2 + D + 1} \sin 2x && (D^2 \rightarrow -2) \\ &= \frac{1}{-2^2 + D + 1} \sin 2x \\ &= \frac{1}{D - 3} \sin 2x \end{aligned}$$

Multiplying and dividing by $(D + 3)$

$$\begin{aligned} &= \frac{(D + 3) \sin 2x}{D^2 - 9} \\ &= \frac{(D + 3) \sin 2x}{-2^2 - 9} = \frac{-1}{13} (2 \cos 2x + 3 \sin 2x) \end{aligned}$$

$$\therefore y = C.F. + P.I. = e^{-\frac{x}{2}} \left[C_1 \cos \frac{\sqrt{3}}{2} x + C_2 \sin \frac{\sqrt{3}}{2} x \right] - \frac{1}{13} (2 \cos 2x + 3 \sin 2x).$$

3. Solve $(D^2 + 5D + 6) y = \cos x + e^{-2x}$.

Solution. The A.E. is

$$m^2 + 5m + 6 = 0$$

$$i.e., \quad (m + 2)(m + 3) = 0$$

$$m = -2, -3$$

$$C.F. = C_1 e^{-2x} + C_2 e^{-3x}$$

$$\begin{aligned} P.I. &= \frac{1}{D^2 + 5D + 6} \cdot [\cos x + e^{-2x}] \\ &= \frac{\cos x}{D^2 + 5D + 6} + \frac{e^{-2x}}{D^2 + 5D + 6} \\ &= P.I._1 + P.I._2 \end{aligned}$$

$$\begin{aligned} P.I._1 &= \frac{\cos x}{D^2 + 5D + 6} && (D^2 = -1^2) \\ &= \frac{\cos x}{-1^2 + 5D + 6} = \frac{\cos x}{5D + 5} \end{aligned}$$

$$= \frac{1}{5} \frac{\cos x (D-1)}{(D+1)(D-1)}$$

$$= \frac{1}{5} \frac{(D-1) \cos x}{D^2 - 1}$$

$$= \frac{1}{5} \frac{-\sin x - \cos x}{-1^2 - 1}$$

$$= \frac{-1}{5} \frac{\sin x + \cos x}{-2}$$

$$= \frac{1}{10} (\sin x + \cos x)$$

$$\text{P.I.}_2 = \frac{e^{-2x}}{D^2 + 5D + 6} \quad (D \rightarrow -2)$$

$$= \frac{e^{-2x}}{(-2)^2 + 5 \times -2 + 6} \quad (Dr = 0)$$

Differential and multiply 'x'

$$= \frac{x e^{-2x}}{2D + 5} \quad (D \rightarrow -2)$$

$$= \frac{x e^{-2x}}{2(-2) + 5} = \frac{x e^{-2x}}{1} = x e^{-2x}$$

$$\text{P.I.} = \frac{1}{10} (\sin x + \cos x) + x e^{-2x}$$

∴ The general solution is

$$y = \text{C.F.} + \text{P.I.}$$

$$y = C_1 e^{-2x} + C_2 e^{-3x} + \frac{1}{10} (\sin x + \cos x) + x e^{-2x}.$$

Type 3

1. Solve $y'' + 3y' + 2y = 12x^2$.

Solution. We have $(D^2 + 3D + 2) y = 12x^2$

A.E. is $m^2 + 3m + 2 = 0$

i.e., $(m + 1)(m + 2) = 0$

$\Rightarrow m = -1, -2$

C.F. = $C_1 e^{-x} + C_2 e^{-2x}$

P.I. = $\frac{12x^2}{D^2 + 3D + 2}$

We need to divide for obtaining the P.I.

$2 + 3D + D^2$	$6x^2 - 18x + 21$
	$12x^2$
	$12x^2 + 36x + 12$
	$- 36x - 12$
	$- 36x - 54$
	42
	42
	0

Note:

$3D(6x^2) = 36x$

$D^2(6x^2) = 12$

Hence, P.I. = $6x^2 - 18x + 21$

\therefore The general solution is

$y = \text{C.F.} + \text{P.I.}$

$y = C_1 e^{-x} + C_2 e^{-2x} + 6x^2 - 18x + 21.$

2. Solve $\frac{d^2y}{dx^2} + 2\frac{dy}{dx} + y = 2x + x^2$.

Solution. We have $(D^2 + 2D + 1) y = 2x + x^2$

A.E. is $m^2 + 2m + 1 = 0$

i.e., $(m + 1)^2 = 0$

i.e., $(m + 1)(m + 1) = 0$

$\Rightarrow m = -1, -1$

C.F. = $(C_1 + C_2 x) e^{-x}$

P.I. = $\frac{2x + x^2}{D^2 + 2D + 1} = \frac{x^2 + 2x}{1 + 2D + D^2}$

$$\begin{array}{r}
 x^2 - 2x + 2 \\
 \hline
 1 + 2D + D^2 \left| \begin{array}{l} x^2 + 2x \\ x^2 + 4x + 2 \\ \hline -2x - 2 \\ -2x - 4 \\ \hline 2 \\ 2 \\ \hline 0 \end{array} \right.
 \end{array}$$

$$\begin{aligned}
 \therefore \text{P.I.} &= x^2 - 2x + 2 \\
 \therefore y &= \text{C.F.} + \text{P.I.} \\
 &= (C_1 + C_2 x) e^{-x} + (x^2 - 2x + 2).
 \end{aligned}$$

Type 4

1. Solve $\frac{d^2 y}{dx^2} + 2 \frac{dy}{dx} - 3y = e^x \cos x$.

Solution. We have

$$(D^2 + 2D - 3)y = e^x \cos x$$

A.E. is $m^2 + 2m - 3 = 0$

i.e., $(m + 3)(m - 1) = 0$

i.e., $m = -3, 1$

$$\text{C.F.} = C_1 e^{-3x} + C_2 e^x$$

$$\text{P.I.} = \frac{1}{D^2 + 2D - 3} e^x \cos x$$

Taking e^x outside the operator and changing D to $D + 1$

$$= e^x \frac{1}{(D+1)^2 + 2(D+1) - 3} \cos x$$

$$= e^x \frac{1}{D^2 + 4D} \cos x \quad (D^2 \rightarrow -1^2)$$

$$\begin{aligned}
&= e^x \frac{1}{-1+4D} \cos x \\
&= e^x \left[\frac{\cos x}{4D-1} \times \frac{4D+1}{4D+1} \right] \\
&= e^x \left[\frac{-4 \sin x + \cos x}{16D^2 - 1} \right] \quad (D^2 \rightarrow -1^2) \\
&= e^x \left[\frac{-4 \sin x + \cos x}{-17} \right] \\
&= \frac{e^x}{17} (4 \sin x - \cos x)
\end{aligned}$$

$$\therefore y = \text{C.F.} + \text{P.I.}$$

$$y = C_1 e^{-3x} + C_2 e^x + \frac{e^x}{17} (4 \sin x - \cos x).$$

2. Solve $(D^3 + 1)y = 5e^x x^2$.

Solution. A.E. is

$$m^3 + 1 = 0$$

$$\text{i.e., } (m + 1)(m^2 - m + 1) = 0$$

$$(m + 1) = 0, m^2 - m + 1 = 0$$

$$m = -1$$

$$m = \frac{1 \pm \sqrt{3}i}{2}$$

$$\text{C.F.} = C_1 e^{-x} + e^{\frac{x}{2}} \left(C_2 \cos \frac{\sqrt{3}}{2}x + C_3 \sin \frac{\sqrt{3}}{2}x \right)$$

$$\text{P.I.} = \frac{1}{D^3 + 1} 5e^x x^2$$

Taking e^x outside the operator and changing D to $D + 1$

$$\begin{aligned}
&= e^x \frac{1}{(D+1)^3 + 1} \cdot 5x^2 \\
&= e^x \frac{5x^2}{D^3 + 3D^2 + 3D + 2}
\end{aligned}$$

$$= \frac{5e^x}{2} \left[\frac{2x^2}{2+3D+3D^2+D^3} \right]$$

(For a convenient division we have multiplied and divided by 2)

$$\begin{array}{r}
 x^2 - 3x + \frac{3}{2} \\
 2 + 3D + 3D^2 + D^3 \overline{) \begin{array}{l} 2x^2 \\ 2x^2 + 6x + 6 \\ \hline -6x - 6 \\ -6x - 9 \\ \hline 3 \\ 3 \\ \hline 0 \end{array}
 \end{array}$$

$$\begin{aligned}
 \therefore \text{P.I.} &= \left(x^2 - 3x + \frac{3}{2} \right) \cdot \frac{5e^x}{2} \\
 &= \frac{5e^x}{4} (2x^2 - 6x + 3)
 \end{aligned}$$

$$y = \text{C.F.} + \text{P.I.}$$

$$= C_1 e^{-x} + e^{\frac{x}{2}} \left\{ C_2 \cos \frac{\sqrt{3}}{2} x + C_3 \sin \frac{\sqrt{3}}{2} x \right\} + \frac{5e^x}{4} (2x^2 - 6x + 3).$$

Type 5

1. Solve $\frac{d^2 y}{dx^2} + 4y = x \sin x$.

Solution. We have

$$(D^2 + 4)y = x \sin x$$

A.E. is $m^2 + 4 = 0$

$$m^2 = -4$$

$$m = \pm 2i$$

$$\text{C.F.} = C_1 \cos 2x + C_2 \sin 2x$$

$$\text{P.I.} = \frac{1}{D^2 + 4} x \sin x$$

Let us use $\frac{xV}{f(D)} = \left[x - \frac{f'(D)}{f(D)} \right] \frac{V}{f(D)}$

$$\frac{x \sin x}{D^2 + 4} = \left[x - \frac{2D}{D^2 + 4} \right] \frac{\sin x}{D^2 + 4} \quad (D^2 \rightarrow -1^2)$$

$$= \frac{x \sin x}{D^2 + 4} - \frac{2D(\sin x)}{(D^2 + 4)^2} \quad (D^2 \rightarrow -1^2)$$

$$= \frac{x \sin x}{3} - \frac{2 \cos x}{3^2}$$

$$= \frac{x \sin x}{3} - \frac{2 \cos x}{9}$$

$$\text{P.I.} = \frac{1}{9} (3x \sin x - 2 \cos x)$$

$$y = \text{C.F.} + \text{P.I.}$$

$$= C_1 \cos 2x + C_2 \sin 2x + \frac{1}{9} (3x \sin x - 2 \cos x)$$

2. Solve $(D^2 + 2D + 1)y = x \cos x$.

Solution. A.E. is

$$m^2 + 2m + 1 = 0$$

i.e., $(m + 1)^2 = 0$

$$m = -1, -1$$

$$\text{C.F.} = (C_1 + C_2 x) e^{-x}$$

$$\text{P.I.} = \frac{x \cos x}{D^2 + 2D + 1}$$

Let us we have

$$\begin{aligned} \frac{xV}{f(D)} &= \left[x - \frac{f'(D)}{f(D)} \right] \cdot \frac{V}{f(D)} \\ &= \left[x - \frac{2D+2}{D^2+2D+1} \right] \cdot \frac{\cos x}{D^2+2D+1} \\ &= \frac{x \cos x}{D^2+2D+1} - \frac{(2D+2) \cos x}{(D^2+2D+1)^2} \\ &= \text{P.I.}_1 - \text{P.I.}_2 \end{aligned}$$

$$\begin{aligned} \text{P.I.}_1 &= \frac{x \cos x}{D^2+2D+1} && (D^2 \rightarrow -1^2) \\ &= \frac{x \cos x \times D}{2D \times D} \\ &= \frac{-x \sin x}{2D^2} && (D^2 \rightarrow -1^2) \\ \text{P.I.}_1 &= \frac{x}{2} \sin x \end{aligned}$$

$$\begin{aligned} \text{P.I.}_2 &= \frac{(2D+2) \cos x}{(D^2+2D+1)^2} && (D^2 \rightarrow -1^2) \\ &= \frac{-2 \sin x + 2 \cos x}{(2D)^2} \\ &= \frac{-2 \sin x + 2 \cos x}{4D^2} && (D^2 = -1^2) \\ &= \frac{2 \sin x - 2 \cos x}{4} \\ &= \frac{1}{2} (\sin x - \cos x) \end{aligned}$$

$$\begin{aligned} \text{P.I.} &= \frac{1}{2} x \sin x - \frac{1}{2} (\sin x - \cos x) \\ &= \frac{1}{2} (x \sin x - \sin x + \cos x) \end{aligned}$$

$$y = \text{C.F.} + \text{P.I.}$$

$$y = (C_1 + C_2 x) e^{-x} + \frac{1}{2} (x \sin x - \sin x + \cos x).$$

METHOD OF UNDETERMINED COEFFICIENTS:

The particular integral of an n^{th} order linear non-homogeneous differential equation $F(D)y=X$ with constant coefficients can be determined by the method of undetermined coefficients provided the RHS function X is an exponential function, polynomial in cosine, sine or sums or product of such functions.

The trial solution to be assumed in each case depend on the form of X . Choose PI from the following table depending on the nature of X .

Sl.No.	RHS function X	Choice of PI y_p
1	$K e^{ax}$	$C e^{ax}$
2	$K \sin(ax+b)$ or $K \cos(ax+b)$	$c_1 \sin(ax+b) + c_2 \cos(ax+b)$
3	$K e^{ax} \sin(ax+b)$ or $K e^{ax} \cos(ax+b)$	$c_1 e^{ax} \sin(ax+b) + c_2 e^{ax} \cos(ax+b)$
4	$K x^n$ where $n=0,1,2,3,\dots$	$c_0 + c_1 x + c_2 x^2 + \dots + c_{n-1} x^{n-1} + c_n x^n$
5	$K x^n e^{ax}$ where $n=0,1,2,3,\dots$	$e^{ax} (c_0 + c_1 x + c_2 x^2 + \dots + c_n x^n)$
6	$K x^n \sin(ax+b)$ or $K x^n \cos(ax+b)$	$a_0 \sin(ax+b) + b_0 \cos(ax+b)$ $+ a_1 .x.\sin(ax+b) + b_1 x \cos(ax+b)$ $+ a_2 .x^2.\sin(ax+b) + b_2 x^2 \cos(ax+b)$ $+ \dots +$ $+ a_n .x^n.\sin(ax+b) + b_n x^n \cos(ax+b)$
7	$K x^n e^{dx} \sin(ax+b)$ or $K x^n e^{dx} \cos(ax+b)$	$e^{dx} (a_0 \sin(ax+b) + b_0 \cos(ax+b)$ $+ a_1 .x.\sin(ax+b) + b_1 x \cos(ax+b)$ $+ a_2 .x^2.\sin(ax+b) + b_2 x^2 \cos(ax+b)$ $+ \dots +$ $+ a_n .x^n.\sin(ax+b) + b_n x^n \cos(ax+b)$

1. Solve by the method of undetermined coefficients $(D^2 - 3D + 2)y = 4e^{3x}$

$$\text{Sol: } m^2 - 3m + 2 = 0 \Rightarrow (m-1)(m-2) = 0 \Rightarrow m = 1, 2$$

$$y_c = c_1 e^x + c_2 e^{2x}$$

Assume PI $y_p = c_1 e^{3x}$ substituting this in the given d.e we determine the unknown coefficient as

$$(D^2 - 3D + 2)y = 4e^{3x}$$

$$9ce^{3x} - 9ce^{3x} + 2ce^{3x} = 4e^{3x}$$

$$2ce^{3x} = 4e^{3x} \Rightarrow c = 2$$

$$\therefore y_p = 2e^{3x}$$

2. Solve $\frac{d^2 y}{dx^2} + 2\frac{dy}{dx} + 4y = 2x^2 + 3e^{-x}$ by the method of undetermined coefficients.

Sol: We have $(D^2 + 2D + 4)y = 2x^2 + 3e^{-x}$

$$\text{A.E is } m^2 + 2m + 4 = 0 \Rightarrow m = \frac{-2 \pm \sqrt{-12}}{2} = \frac{-2 \pm 2\sqrt{3}i}{2} = -1 \pm \sqrt{3}i$$

$$y_c = e^{-x} \left[c_1 \cos \sqrt{3}x + c_2 \sin \sqrt{3}x \right]$$

Assume PI in the form $y = a_1 x^2 + a_2 x + a_3 + a_4 e^{-x}$

$$Dy = 2a_1 x + a_2 - a_4 e^{-x}$$

$$D^2 y = 2a_1 + a_4 e^{-x}$$

Substituting these values in the given d.e

$$\text{We get } 2a_1 + a_4 e^{-x} + 2(2a_1 x + a_2 - a_4 e^{-x}) + 4(a_1 x^2 + a_2 x + a_3 + a_4 e^{-x}) = 2x^2 + 3e^{-x}$$

Equating corresponding coefficient on both sides, we get

$$x^2: 4a_1 = 2 \Rightarrow a_1 = \frac{1}{2}$$

$$x: 4a_1 + 4a_2 = 0 \Rightarrow 4\left(\frac{1}{2}\right) + 4a_2 = 0$$

$$2 + 4a_2 = 0 \Rightarrow 4a_2 = -2 \Rightarrow a_2 = -\frac{1}{2}$$

$$c: 2a_1 + 2a_2 + 4a_3 = 0$$

$$2\left(\frac{1}{2}\right) + 2\left(-\frac{1}{2}\right) + 4a_3 = 0 \Rightarrow a_3 = 0$$

$$e^{-x}: a_4 - 2a_4 + 4a_4 = 3$$

$$3a_4 = 3 \Rightarrow a_4 = 1$$

$$\therefore \text{PI: } y_p = \frac{1}{2}x^2 - \frac{1}{2}x + e^{-x}$$

$$y = e^{-x} \left(c_1 \cos \sqrt{3}x + c_2 \sin \sqrt{3}x \right) + \frac{1}{2}x^2 - \frac{1}{2}x + e^{-x}$$

3. Solve by using the method of undetermined coefficients $\frac{d^2y}{dx^2} - 9y = x^3 + e^{2x} - \sin 3x$

Sol: We have $(D^2 - 9)y = x^3 + e^{2x} - \sin 3x$

A.E is $m^2 - 9 = 0 \Rightarrow m^2 = 9 \Rightarrow m = \pm 3$

$$y_c = c_1 e^{3x} + c_2 e^{-3x}$$

Choose PI as $y = Ax^3 + Bx^2 + Cx + D + Ee^{2x} + F \sin 3x + G \cos 3x$

$$y' = 3Ax^2 + 2Bx + C + 2Ee^{2x} + 3F \cos 3x - 3G \sin 3x$$

$$y'' = 6Ax + 2B + 4Ee^{2x} - 9F \sin 3x - 9G \cos 3x$$

Substituting these values in the given d.e, we get

$$\begin{aligned} 6Ax + 2B + 4Ee^{2x} - 9F \sin 3x - 9G \cos 3x - 9(Ax^3 + Bx^2 + Cx + D + Ee^{2x} + F \sin 3x + G \cos 3x) \\ = x^3 + e^{2x} - \sin 3x \end{aligned}$$

Equating the coefficient of

$$x^3 : -9A = 1 \Rightarrow A = -\frac{1}{9}$$

$$x^2 : -9B = 0 \Rightarrow B = 0$$

$$x : 6A - 9C = 0 \Rightarrow 6\left(-\frac{1}{9}\right) - 9C = 0$$

$$\Rightarrow -\frac{2}{3} - 9C = 0 \Rightarrow 9C = -\frac{2}{3} \therefore C = -\frac{2}{27}$$

$$C : 2B - 9D = 0 \Rightarrow D = 0$$

$$e^{2x} : 4E - 9E = 1 \Rightarrow -5E = 1 \Rightarrow E = -\frac{1}{5}$$

$$\sin 3x : -9F - 9G = 0 \Rightarrow F = \frac{1}{18}$$

$$\cos 3x : -9G - 9G = 0 \Rightarrow G = 0$$

$$\therefore y_p = -\frac{1}{9}x^3 - \frac{2x}{27} - \frac{1}{5}e^{2x} + \frac{1}{18}\sin 3x$$

Complete solution $y = y_c + y_p$

$$\therefore y = c_1 e^{3x} + c_2 e^{-3x} - \frac{1}{9} x^3 - \frac{2x}{27} - \frac{1}{5} e^{2x} + \frac{1}{18} \sin 3x$$

METHOD OF VARIATION OF PARAMETERS:

Consider a linear differential equation of second order

$$\frac{d^2 y}{dx^2} + a_1 \frac{dy}{dx} + a_2 y = \phi(x) \quad \dots(1)$$

where a_1, a_2 are functions of 'x'. If the complimentary function of this equation is known then we can find the particular integral by using the method known as the method of variation of parameters.

Suppose the complimentary function of the Eqn. (1) is

C.F. = $C_1 y_1 + C_2 y_2$ where C_1 and C_2 are constants and y_1 and y_2 are the complementary solutions of Eqn. (1)

The Eqn. (1) implies that

$$y_1'' + a_1 y_1' + a_2 y_1 = 0 \quad \dots(2)$$

$$y_2'' + a_1 y_2' + a_2 y_2 = 0 \quad \dots(3)$$

We replace the arbitrary constants C_1, C_2 present in C.F. by functions of x , say A, B respectively,

$$\therefore y = Ay_1 + By_2 \quad \dots(4)$$

is the complete solution of the given equation.

The procedure to determine A and B is as follows.

$$\text{From Eqn. (4)} \quad y' = (Ay_1' + By_2') + (A'y_1 + B'y_2) \quad \dots(5)$$

We shall choose A and B such that

$$A'y_1 + B'y_2 = 0 \quad \dots(6)$$

$$\text{Thus Eqn. (5) becomes } y_1' = Ay_1' + By_2' \quad \dots(7)$$

Differentiating Eqn. (7) w.r.t. 'x' again, we have

$$y'' = (Ay_1'' + Ay_2'') + (A'y_1' + B'y_2') \quad \dots(8)$$

Thus, Eqn. (1) as a consequence of (4), (7) and (8) becomes

$$A'y_1' + B'y_2' = \phi(x) \quad \dots(9)$$

Let us consider equations (6) and (9) for solving

$$A'y_1 + B'y_2 = 0 \quad \dots(6)$$

$$A'y_1' + B'y_2' = \phi(x) \quad \dots(9)$$

Solving A' and B' by cross multiplication, we get

$$A' = \frac{-y_2 \phi(x)}{W}, B' = \frac{y_1 \phi(x)}{W} \quad \dots(10)$$

Find A and B

Integrating,
$$A = -\int \frac{y_2 \phi(x)}{W} dx + k_1$$

$$B = \int \frac{y_1 \phi(x)}{W} dx + k_2$$

where
$$W = \begin{vmatrix} y_1 & y_2 \\ y_1' & y_2' \end{vmatrix} = y_1 y_2' - y_2 y_1'$$

Substituting the expressions of A and B

$$y = Ay_1 + By_2 \text{ is the complete solution.}$$

1. Solve by the method of variation of parameters

$$\frac{d^2 y}{dx^2} + y = \operatorname{cosec} x.$$

Solution. We have

$$(D^2 + 1) y = \operatorname{cosec} x$$

A.E. is $m^2 + 1 = 0 \Rightarrow m^2 = -1 \Rightarrow m = \pm i$

Hence the C.F. is given by

$$\therefore y_c = C_1 \cos x + C_2 \sin x \quad \dots(1)$$

$$y = A \cos x + B \sin x \quad \dots(2)$$

be the complete solution of the given equation where A and B are to be found.

The general solution is $y = Ay_1 + By_2$

We have $y_1 = \cos x$ and $y_2 = \sin x$

$$y_1' = -\sin x \text{ and } y_2' = \cos x$$

$$W = y_1 y_2' - y_2 y_1'$$

$$= \cos x \cdot \cos x + \sin x \cdot \sin x = \cos^2 x + \sin^2 x = 1$$

$$\begin{aligned} A' &= \frac{-y_2 \phi(x)}{W}, & B' &= \frac{y_1 \phi(x)}{W} \\ &= \frac{-\sin x \cdot \operatorname{cosec} x}{1}, & B' &= \frac{\cos x \cdot \operatorname{cosec} x}{1} \\ A' &= -1, & B' &= \cot x \end{aligned}$$

$$A = \int (-1) dx + C_1, \text{ i.e., } A = -x + C_1$$

$$B = \int \cot x dx + C_2, \text{ i.e., } B = \log \sin x + C_2$$

Hence the general solution of the given Eqn. (2) is

$$y = C_1 \cos x + C_2 \sin x - x \cos x + \sin x \log \sin x.$$

2. Solve by the method of variation of parameters

$$\frac{d^2y}{dx^2} + 4y = 4 \tan 2x.$$

Solution. We have

$$(D^2 + 4) y = 4 \tan 2x$$

A.E. is $m^2 + 4 = 0$

where $\phi(x) = 4 \tan 2x$.

i.e., $m = \pm 2i$

Hence the complementary function is given by

$$y_c = C_1 \cos 2x + C_2 \sin 2x$$

$$y = A \cos 2x + B \sin 2x$$

...(1)

be the complete solution of the given equation where A and B are to be found

We have

$$y_1 = \cos 2x \quad \text{and} \quad y_2 = \sin 2x$$

$$y_1' = -2 \sin 2x \quad \text{and} \quad y_2' = 2 \cos 2x$$

Then

$$W = y_1 y_2' - y_2 y_1'$$

$$= \cos 2x \cdot 2 \cos 2x + 2 \sin 2x \cdot \sin 2x$$

$$= 2 (\cos^2 2x + \sin^2 2x)$$

$$= 2$$

Also,

$$\phi(x) = 4 \tan 2x$$

$$A' = \frac{-y_2 \phi(x)}{W} \quad \text{and} \quad B' = \frac{y_1 \phi(x)}{W}$$

$$A' = \frac{-\sin 2x \cdot 4 \tan 2x}{2}, B' = \frac{-\cos 2x \cdot 4 \tan 2x}{2}$$

$$A' = \frac{-2 \sin^2 2x}{\cos 2x}, B' = 2 \sin 2x$$

On integrating, we get

$$\begin{aligned} A &= -2 \int \frac{\sin^2 2x}{\cos 2x} dx, B = 2 \int \sin 2x dx \\ &= -2 \int \frac{1 - \cos^2 2x}{\cos 2x} dx \\ &= -2 \int \{\sec 2x - \cos 2x\} dx \\ &= -2 \left\{ \frac{1}{2} \log (\sec 2x + \tan 2x) - \frac{1}{2} \sin 2x \right\} \end{aligned}$$

$$A = -\log (\sec 2x + \tan 2x) + \sin 2x + C_1$$

$$\begin{aligned} B &= 2 \int \sin 2x dx \\ &= \frac{2(-\cos 2x)}{2} + C_2 \end{aligned}$$

$$B = -\cos 2x + C_2$$

Substituting these values of A and B in Eqn. (1), we get

$$y = C_1 \cos 2x + C_2 \sin 2x - \cos 2x \log (\sec 2x + \tan 2x)$$

which is the required general solution.

MODULE - 2

DIFFERENTIAL EQUATIONS –II

SOLUTION OF SIMULTANEOUS DIFFERENTIAL EQUATIONS:

Let us suppose that x and y are functions of an independent variable ' t ' connected by a system of

first order equation with $D = \frac{d}{dt}$

$$f_1(D) x + f_2(D) y = \phi_1(t) \quad \dots(1)$$

$$g_1(D) x + g_2(D) y = \phi_2(t) \quad \dots(2)$$

By solving a system of linear algebraic equations in cancelling either of the dependent variables (x or y) operating (1) with $g_1(D)$ and (2) with $f_1(D)$, x cancels out by subtraction. We obtain a second order differential equation in y . Which can be solved x can be obtained independently by cancelling y or by substituting the obtained $y(t)$ in a suitable equation.

Let us suppose that x and y are functions of an independent variable ' t ' connected by a system of

first order equation with $D = \frac{d}{dt}$

$$f_1(D) x + f_2(D) y = \phi_1(t) \quad \dots(1)$$

$$g_1(D) x + g_2(D) y = \phi_2(t) \quad \dots(2)$$

By solving a system of linear algebraic equations in cancelling either of the dependent variables (x or y) operating (1) with $g_1(D)$ and (2) with $f_1(D)$, x cancels out by subtraction. We obtain a second order differential equation in y . Which can be solved x can be obtained independently by cancelling y or by substituting the obtained $y(t)$ in a suitable equation.

1. Solve $\frac{dx}{dt} - 7x + y = 0$, $\frac{dx}{dt} - 2x - 5y = 0$.

Solution. Taking $D = \frac{d}{dt}$, we have the system of equations

$$(D - 7)x + y = 0 \quad \dots(1)$$

$$-2x + (D - 5)y = 0 \quad \dots(2)$$

Multiply (1) by 2 and operate (2) by $(D - 7)$

i.e., $2(D - 7)x + 2y = 0$

$$-2(D - 7)x + (D - 5)(D - 7)y = 0$$

Adding $[(D - 5)(D - 7) + 2]y = 0$ or

$$(D^2 - 12D + 37)y = 0$$

A.E. is $m^2 - 12m + 37 = 0$

or $(m - 6)^2 + 1 = 0$

$$\Rightarrow m - 6 = \pm i$$

$$m = 6 \pm i$$

Thus $y = e^{6t} (C_1 \cos t + C_2 \sin t) \quad \dots(3)$

By considering $\frac{dy}{dt} - 2x - 5y = 0$, we get

$$x = \frac{1}{2} \left(\frac{dy}{dt} - 5y \right)$$

$$\begin{aligned} \therefore x &= \frac{1}{2} \left\{ \frac{d}{dt} [e^{6t} (C_1 \cos t + C_2 \sin t)] - 5e^{6t} (C_1 \cos t + C_2 \sin t) \right\} \\ &= \frac{1}{2} \left\{ e^{6t} (-C_1 \sin t + C_2 \cos t) + 6e^{6t} (C_1 \cos t + C_2 \sin t) \right. \\ &\quad \left. - 5e^{6t} (C_1 \cos t + C_2 \sin t) \right\} \end{aligned}$$

$$x = \frac{1}{2} \left\{ e^{6t} (-C_1 \sin t + C_2 \cos t) + e^{6t} (C_1 \cos t + C_2 \sin t) \right\}$$

Thus $x = \frac{1}{2} \left\{ (C_1 + C_2) e^{6t} \cos t + (C_2 - C_1) e^{6t} \sin t \right\} \quad \dots(4)$

(3) and (4) represents the complete solution of the given system of equations.

2. Solve: $\frac{dx}{dt} = 2x - 3y$, $\frac{dy}{dt} = y - 2x$ given $x(0) = 8$ and $y(0) = 3$.

Solution. Taking $D = \frac{d}{dt}$ we have the system of equations.

$$Dx = 2x - 3y; \quad Dy = y - 2x$$

$$\text{i.e.,} \quad (D - 2)x + 3y = 0 \quad \dots(1)$$

$$2x + (D - 1)y = 0 \quad \dots(2)$$

Multiplying (1) by 2 and (2) by $(D - 2)$, we get

$$2(D - 2)x + 6y = 0$$

$$2(D - 2)x + (D - 1)(D - 2)y = 0$$

Subtracting, we get $(D^2 - 3D - 4)y = 0$

$$\text{A.E. is} \quad m^2 - 3m - 4 = 0$$

$$\text{or} \quad (m - 4)(m + 1) = 0 \quad \Rightarrow \quad m = 4, -1$$

$$\therefore \quad y = C_1 e^{4t} + C_2 e^{-t} \quad \dots(3)$$

By considering $\frac{dy}{dt} = y - 2x$, we get

$$x = \frac{1}{2} \left\{ y - \frac{dy}{dt} \right\}$$

$$\begin{aligned} \text{i.e.,} \quad x &= \frac{1}{2} \left\{ C_1 e^{4t} + C_2 e^{-t} - (4C_1 e^{4t} - C_2 e^{-t}) \right\} \\ &= \frac{1}{2} (-3C_1 e^{4t} + 2C_2 e^{-t}) \end{aligned} \quad \dots(4)$$

We have conditions $x = 8$, $y = 3$ at $t = 0$

$$\text{Hence (3) and (4) become } C_1 + C_2 = 3 \text{ and } -\frac{3C_1}{2} + C_2 = 8.$$

Solving these equations, we get $C_2 = 5$, $C_1 = -2$

Thus

$$x = 3e^{4t} + 5e^{-t}$$

$$y = -2e^{4t} + 5e^{-t} \text{ is the required solution.}$$

3. Solve: $\frac{dx}{dt} - 2y = \cos 2t$, $\frac{dy}{dt} + 2x = \sin 2t$ given that $x = 1$, $y = 0$ at $t = 0$.

Solution. Taking $D = \frac{d}{dt}$ we have the system of equations

$$Dx - 2y = \cos 2t \quad \dots(1)$$

$$2x + Dy = \sin 2t \quad \dots(2)$$

Multiplying (1) by D and (2) by 2, we have

$$D^2x - 2Dy = D(\cos 2t) = -2 \sin 2t$$

$$4x + 2Dy = 2 \sin 2t$$

Adding, we get $(D^2 + 4)x = 0$

A.E. is $m^2 + 4 = 0 \Rightarrow m = \pm 2i$

$\therefore x = C_1 \cos 2t + C_2 \sin 2t$... (3)

By considering $\frac{dx}{dt} - 2y = \cos 2t$, we get

$$y = \frac{1}{2} \left[\frac{dx}{dt} - \cos 2t \right]$$

i.e., $y = \frac{1}{2} \left[\frac{d}{dt} (C_1 \cos 2t + C_2 \sin 2t) - \cos 2t \right]$

$$= \frac{1}{2} [-2C_1 \sin 2t + 2C_2 \cos 2t - \cos 2t]$$

$$y = -C_1 \sin 2t + \left(C_2 - \frac{1}{2} \right) \cos 2t$$
 ... (4)

Equation (3) and (4) represents the general solution

Applying the given conditions $x = 1$ at $t = 0$

Hence (3) becomes, $1 = C_1 + 0 \Rightarrow C_1 = 1$

$$y = 0 \text{ at } t = 0$$

Hence (4) becomes, $0 = 0 + \left(C_2 - \frac{1}{2} \right) \Rightarrow C_2 = \frac{1}{2}$

Substituting these values in (3) and (4), we get

$$x = \cos 2t + \frac{1}{2} \sin 2t$$

$$y = -\sin 2t$$

Which is the required solution.

SOLUTION OF CAUCHY'S HOMOGENEOUS LINEAR EQUATION AND LEGENDRE'S LINEAR EQUATION

A linear differential equation of the form

$$x^n \frac{d^n y}{dx^n} + a_1 x^{n-1} \cdot \frac{d^{n-1} y}{dx^{n-1}} + a_2 x^{n-2} \frac{d^{n-2} y}{dx^{n-2}} + \dots + a_{n-1} x \cdot \frac{dy}{dx} + a_n y = \phi(x) \quad \dots(1)$$

Where $a_1, a_2, a_3 \dots a_n$ are constants and $\phi(x)$ is a function of x is called a homogeneous linear differential equation of order n .

The equation can be transformed into an equation with constant coefficients by changing the independent variable x to z by using the substitution $x = e^z$ or $z = \log x$

Now
$$z = \log x \Rightarrow \frac{dz}{dx} = \frac{1}{x}$$

i.e.,
$$x \frac{d^2 y}{dx^2} = \frac{d^2 y}{dz^2} \cdot \frac{1}{x} - \frac{dy}{dx}$$

$$= \frac{1}{x} \cdot \frac{d^2 y}{dz^2} - \frac{1}{x} \cdot \frac{dy}{dz}$$

i.e.,
$$x^2 \frac{d^2 y}{dx^2} = \frac{d^2 y}{dz^2} - \frac{dy}{dz}$$

i.e.,
$$x^2 \frac{d^2 y}{dx^2} = (D^2 - D) y = D (D - 1) y$$

Similarly,
$$x^3 \frac{d^3 y}{dx^3} = D (D - 1) (D - 2) y$$

.....

$$x^n \frac{d^n y}{dx^n} = D (D - 1) \dots (D - n + 1) y$$

Substituting these values of $x \frac{dy}{dx}, x^2 \frac{d^2 y}{dx^2}, \dots, x^n \frac{d^n y}{dx^n}$ in Eqn. (1), it reduces to a linear differential equation with constant coefficient can be solved by the method used earlier.

Also, an equation of the form,

$$(ax + b)^n \cdot \frac{d^n y}{dx^n} + a_1 (ax + b)^{n-1} \cdot \frac{d^{n-1} y}{dx^{n-1}} + \dots any = \phi(x) \quad \dots(2)$$

where a_1, a_2, \dots, a_n are constants and $\phi(x)$ is a function of x is called a homogeneous linear differential equation of order n . It is also called “Legendre’s linear differential equation”.

This equation can be reduced to a linear differential equation with constant coefficients by using the substitution.

$$ax + b = e^z \text{ or } z = \log (ax + b)$$

As above we can prove that

$$(ax + b) \cdot \frac{dy}{dx} = a Dy$$

$$(ax + b)^2 \cdot \frac{d^2y}{dx^2} = a^2 D (D - 1) y$$

.....

$$(ax + b)^n \cdot \frac{d^n y}{dx^n} = a^n D (D - 1)(D - 2) \dots (D - n + 1) y$$

The reduced equation can be solved by using the methods of the previous section.

PROBLEMS:

1. Solve $x^2 \frac{d^2y}{dx^2} - 2x \frac{dy}{dx} - 4y = x^4$.

Solution. The given equation is

$$x^2 \frac{d^2y}{dx^2} - 2x \frac{dy}{dx} - 4y = x^4 \tag{1}$$

Substitute $x = e^z$ or $z = \log x$

So that $x \frac{dy}{dx} = Dy, \quad x^2 \frac{d^2y}{dx^2} = D(D - 1) y$

The given equation reduces to

$$\begin{aligned} D(D - 1) y - 2Dy - 4y &= (e^z)^4 \\ [D(D - 1) - 2D - 4] y &= e^{4z} \\ \text{i.e., } (D^2 - 3D - 4) y &= e^{4z} \end{aligned} \tag{2}$$

which is an equation with constant coefficients

A.E. is $m^2 - 3m - 4 = 0$

i.e., $(m - 4)(m + 1) = 0$

$\therefore m = 4, -1$

C.F. is C.F. = $C_1 e^{4z} + C_2 e^{-z}$

P.I. = $\frac{1}{D^2 - 3D - 4} e^{4z} \quad D \rightarrow 4$

= $\frac{1}{(4)^2 - 3(4) - 4} e^{4z} \quad Dr = 0$

= $\frac{1}{2D - 3} z e^{4z} \quad D \rightarrow 4$

= $\frac{1}{(2)(4) - 3} z e^{4z}$

= $\frac{1}{5} z e^{4z}$

∴ The general solution of (2) is

$$y = \text{C.F.} + \text{P.I.}$$

$$y = C_1 e^{4z} + C_2 e^{-z} + \frac{1}{5} z e^{4z}$$

Substituting $e^z = x$ or $z = \log x$, we get

$$y = C_1 x^4 + C_2 x^{-1} + \frac{1}{5} \log x (x^4)$$

$$y = C_1 x^4 + \frac{C_2}{x} + \frac{x^4}{5} \log x$$

is the general solution of the Eqn. (1).

2. Solve $x^2 \frac{d^2 y}{dx^2} - 3x \frac{dy}{dx} + 4y = (x + 1)^2$.

Solution. The given equation is

$$x^2 \frac{d^2 y}{dx^2} - 3x \frac{dy}{dx} + 4y = (x + 1)^2 \quad \dots(1)$$

Substituting $x = e^z$ or $z = \log x$

Then $x \frac{dy}{dx} = Dy, \quad x^2 \frac{d^2 y}{dx^2} = D(D - 1)y$

∴ Eqn. (1) reduces to

$$D(D - 1)y - 3Dy + 4y = (e^z + 1)^2$$

i.e., $(D^2 - 4D + 4)y = e^{2z} + 2e^z + 1$

which is a linear equation with constant coefficients.

A.E. is $m^2 - 4m + 4 = 0$

i.e., $(m - 2)^2 = 0$

∴ $m = 2, 2$

C.F. = $(C_1 + C_2 z) e^{2z}$

$$\text{P.I.} = \frac{1}{(D-2)^2} (e^{2z} + 2e^z + 1) \quad \dots(2)$$

$$= \frac{e^{2z}}{(D-2)^2} + \frac{2e^z}{(D-2)^2} + \frac{e^{0z}}{(D-2)^2}$$

$$= \text{P.I.}_1 + \text{P.I.}_2 + \text{P.I.}_3$$

$$\text{P.I.}_1 = \frac{e^{2z}}{(D-2)^2} \quad (D \rightarrow 2)$$

$$= \frac{e^{2z}}{(2-2)^2} \quad (Dr = 0)$$

$$= \frac{ze^{2z}}{2(D-2)} \quad (D \rightarrow 2)$$

$$= \frac{ze^{2z}}{2(2-2)} \quad (Dr = 0)$$

$$\text{P.I.}_1 = \frac{z^2 e^{2z}}{2}$$

$$\text{P.I.}_2 = \frac{2e^z}{(D-2)^2} \quad (D \rightarrow 1)$$

$$= \frac{2e^z}{(-1)^2}$$

$$\text{P.I.}_2 = 2e^z$$

$$\text{P.I.}_3 = \frac{e^{0z}}{(D-2)^2} \quad (D \rightarrow 0)$$

$$= \frac{e^{0z}}{4} = \frac{1}{4}$$

$$\text{P.I.} = \frac{z^2}{2} e^{2z} + 2e^z + \frac{1}{4}$$

The general solution of Eqn. (2) is

$$y = \text{C.F.} + \text{P.I.}$$

$$y = (C_1 + C_2 z) e^{2z} + \frac{z^2 e^{2z}}{2} + 2e^z + \frac{1}{4}$$

Substituting

$$e^z = x \text{ or } z = \log x, \text{ we get}$$

$$y = (C_1 + C_2 \log x) x^2 + \frac{x^2 (\log x)^2}{2} + 2x + \frac{1}{4}$$

is the general solution of the equation (1).

3. Solve $x^2 \frac{d^2 y}{dx^2} + 2x \frac{dy}{dx} - 12y = x^2 \log x$.

Solution. The given Eqn. is

$$x^2 \frac{d^2 y}{dx^2} + 2x \frac{dy}{dx} - 12y = x^2 \log x \quad \dots(1)$$

Substituting $x = e^z$ or $z = \log x$, so that

$$x \frac{dy}{dx} = Dy, \quad \text{and} \quad x^2 \frac{d^2 y}{dx^2} = D(D-1)y$$

Then Eqn. (1) reduces to

$$D(D-1)y + 2Dy - 12y = e^{2z} z$$

$$\text{i.e.,} \quad (D^2 + D - 12)y = ze^{2z} \quad \dots(2)$$

which is the Linear differential equation with constant coefficients.

A.E. is $m^2 + m - 12 = 0$

i.e., $(m + 4)(m - 3) = 0$

$\therefore m = -4, 3$

C.F. = $C_1e^{-4z} + C_2e^{3z}$

P.I. = $\frac{1}{D^2 + D - 12}ze^{2z}$

= $e^{2z} \frac{z}{(D+2)^2 + (D+2) - 12}$ ($D \rightarrow D + 2$)

= $e^{2z} \left[\frac{z}{D^2 + 5D - 6} \right]$

$-\frac{1}{6}z - \frac{5}{36}$

$-6 + 5D + D^2$	z
	$z - \frac{5}{6}$
	$\frac{5}{6}$
	$\frac{5}{6}$
	0

P.I. = $e^{2z} \left[-\frac{z}{6} - \frac{5}{36} \right] = \frac{-e^{2z}}{6} \left[z + \frac{5}{6} \right]$

\therefore General solution of Eqn. (2) is

$y = \text{C.F.} + \text{P.I.}$

$y = C_1e^{-4z} + C_2e^{3z} - \frac{e^{2z}}{6} \left(z + \frac{5}{6} \right)$

Substituting

$e^z = x$ or $z = \log x$, we get

$y = C_1x^{-4} + C_2x^3 - \frac{x^2}{6} \left(\log x + \frac{5}{6} \right)$

$y = \frac{C_1}{x^4} + C_2x^3 - \frac{x^2}{6} \left(\log x + \frac{5}{6} \right)$

which is the general solution of Eqn. (1).

Differential equations of first order and higher degree

If $y=f(x)$, we use the notation $\frac{dy}{dx} = p$ throughout this unit.

A differential equation of first order and n^{th} degree is the form

$$A_0 p^n + A_1 p^{n-1} + A_2 p^{n-2} + \dots + A_n = 0$$

Where $A_0, A_1, A_2, \dots, A_n$ are functions of x and y . This being a differential equation of first order, the associated general solution will contain only one arbitrary constant. We proceed to discuss equations solvable for P or y or x , wherein the problem is reduced to that of solving one or more differential equations of first order and first degree. We finally discuss the solution of clairaut's equation.

Equations solvable for p

Supposing that the LHS of (1) is expressed as a product of n linear factors, then the equivalent form of (1) is

$$p - f_1(x, y) \quad p - f_2(x, y) \quad \dots \quad p - f_n(x, y) = 0 \quad \dots(2)$$

$$\Rightarrow \quad p - f_1(x, y) = 0, \quad p - f_2(x, y) = 0 \dots \quad p - f_n(x, y) = 0$$

All these are differential equations of first order and first degree. They can be solved by the known methods. If $F_1(x, y, c) = 0, F_2(x, y, c) = 0, \dots, F_n(x, y, c) = 0$ respectively represents the solution of these equations then the general solution is given by the product of all these solution. Note: We need to present the general solution with the same arbitrary constant in each factor.

1. Solve : $y \left(\frac{dy}{dx} \right)^2 + x - y \frac{dy}{dx} - x = 0$

Sol: The given equation is

$$yp^2 + (x - y)p - x = 0$$

$$\therefore p = \frac{-(x - y) \pm \sqrt{(x - y)^2 + 4xy}}{2y}$$

$$p = \frac{(y - x) \pm (x + y)}{2y}$$

$$\text{ie., } p = \frac{y - x + x + y}{2y} \quad \text{or} \quad p = \frac{y - x - x - y}{2y}$$

$$\text{ie., } p = 1 \quad \text{or} \quad p = -x/y$$

We have,

$$\frac{dy}{dx} = 1 \Rightarrow y = x + c \quad \text{or} \quad (y - x - c) = 0$$

$$\text{Also, } \frac{dy}{dx} = \frac{-x}{y} \quad \text{or} \quad ydy + xdx = 0 \Rightarrow \int y dy + \int x dx = k$$

$$\text{ie., } \frac{y^2}{2} + \frac{x^2}{2} = k \quad \text{or} \quad y^2 + x^2 = 2k \quad \text{or} \quad (x^2 + y^2 - c) = 0$$

Thus the general solution is given by $(y-x-c)(x^2 + y^2 - c) = 0$

2. Solve : $x(y')^2 - (2x+3y)y' + 6y = 0$

Sol: The given equation with the usual notation is,

$$xp^2 - (2x+3y)p + 6y = 0$$

$$p = \frac{(2x+3y) \pm \sqrt{(2x+3y)^2 - 24xy}}{2x}$$

$$p = \frac{(2x+3y) \pm (2x-3y)}{2x} = 2 \quad \text{or} \quad \frac{3y}{x}$$

We have

$$\frac{dy}{dx} = 2 \Rightarrow \int dy = 2 \int dx + c \quad \text{or} \quad y = 2x + c \quad \text{or} \quad (y - 2x - c) = 0$$

$$\text{Also } \frac{dy}{dx} = \frac{3y}{x} \quad \text{or} \quad \frac{dy}{y} = 3 \frac{dx}{x} \Rightarrow \int \frac{dy}{y} = 3 \int \frac{dx}{x} + k$$

$$\text{ie., } \log y = 3 \log x + k \quad \text{or} \quad \log y = \log x^3 + \log c, \quad \text{where } k = \log c$$

$$\text{ie., } \log y = \log(cx^3) \Rightarrow y = cx^3 \quad \text{or} \quad y - cx^3 = 0$$

Thus the general solution is $(y-2x-c)(y-cx^3) = 0$

3) Solve $p(p+y) = x(x+y)$

Sol: The given equation is, $p^2 + py - x(x+y) = 0$

$$p = \frac{-y \pm \sqrt{y^2 + 4x(x+y)}}{2}$$

$$p = \frac{-y \pm \sqrt{4x^2 + 4xy + y^2}}{2} = \frac{-y \pm (2x+y)}{2}$$

$$\text{ie., } p = x \quad \text{or} \quad p = \frac{-2(y+x)}{2} = -(y+x)$$

We have,

$$\frac{dy}{dx} = x \Rightarrow y = \frac{x^2}{2} + k$$

$$\text{Also, } \frac{dy}{dx} = -y + x$$

ie., $\frac{dy}{dx} + y = -x$, is a linear d.e (similar to the previous problem)

$$P = 1, Q = -x; e^{\int P dx} = e^x$$

$$\text{Hence } ye^x = \int -xe^x dx + c$$

ie., $ye^x = -(xe^x - e^x) + c$, integrating by parts.

Thus the general solution is given by $(2y - x^2 - c)[e^x(y + x - 1) - c] = 0$

Equations solvable for y:

We say that the given differential equation is solvable for y, if it is possible to express y in terms of x and p explicitly. The method of solving is illustrated stepwise.

$$Y = f(x, p)$$

We differentiate (1) w.r.t x to obtain

$$\frac{dy}{dx} = p = F\left(x, y, \frac{dp}{dx}\right)$$

Here it should be noted that there is no need to have the given equation solvable for y in the explicit form (1). By recognizing that the equation is solvable for y, we can proceed to differentiate the same w.r.t. x. We notice that (2) is a differential equation of first order in p and x. We solve the same to obtain the solution in the form $\phi(x, p, c) = 0$

By eliminating p from (1) and (3) we obtain the general solution of the given differential equation in the form $G(x, y, c) = 0$

Remark: Suppose we are unable to eliminate p from (1) and (3), we need to solve for x and y from the same to obtain.

$$x = F_1(p, c), \quad y = F_2(p, c)$$

Which constitutes the solution of the given equation regarding p as a parameter.

Equations solvable for x

We say that the given equation is solvable for x, if it is possible to express x in terms of y and p. The method of solving is identical with that of the earlier one and the same is as follows.

$$x = f(y, p)$$

Differentiate w.r.t.y to obtain

$$\frac{dx}{dy} = \frac{1}{p} = F\left(x, y, \frac{dp}{dy}\right)$$

(2) Being a differential equation of first order in p and y the solution is of the form.

$$\phi(y, p, c) = 0$$

By eliminating p from (1) and (3) we obtain the general solution of the given d.e in the form

$$G(x, y, c) = 0$$

Note: The content of the remark given in the previous article continue to hold good here also.

1. **Solve:** $y - 2px = \tan^{-1}(xp^2)$

Sol: By data, $y = 2px = + \tan^{-1}(xp^2)$

The equation is of the form $y = f(x, p)$, solvable for y.

Differentiating (1) w.r.t.x,

$$p - 2p - 2 \frac{dp}{dx} x = \frac{1}{1+x^2 p^4} \left[x \cdot 2p \frac{dp}{dx} + p^2 \right]$$

$$\text{ie., } -p - 2x \frac{dp}{dx} = \frac{1}{1+x^2 p^4} \left[2xp \frac{dp}{dx} + p^2 \right]$$

$$\text{ie., } -p - \frac{p^2}{1+x^2 p^4} = 2x \frac{dp}{dx} \left[\frac{p}{1+x^2 p^4} + 1 \right]$$

$$\text{ie., } -p \left[\frac{1+x^2 p^4 + p}{1+x^2 p^4} \right] = 2x \frac{dp}{dx} \left[\frac{p+1+x^2 p^4}{1+x^2 p^4} \right]$$

$$\text{ie., } \log x + 2 \log p = k$$

$$\text{consider } y = 2px + \tan^{-1}(xp^2)$$

$$\text{and } xp^2 = c$$

Using (2) in (1) we have,

$$y = 2\sqrt{c/x} \cdot x + \tan^{-1}(c)$$

Thus $y = 2\sqrt{cx} + \tan^{-1} c$, is the general solution.

2. Obtain the general solution and the singular solution of the equation

$$y + px = p^2 x^4$$

Sol: The given equation is solvable for y only.

$$y + px = p^2 x^4$$

Differentiating w.r.t x,

$$\text{ie., } -2p = x \frac{dp}{dx} \text{ or } \frac{dx}{x} = \frac{-dp}{2p} \Rightarrow \int \frac{dx}{x} + \frac{1}{2} \int \frac{dp}{p}$$

$$\text{ie., } \log x + \log \sqrt{p} = k \text{ or } \log(x\sqrt{p}) = \log c \Rightarrow x\sqrt{p} = c$$

$$\text{Consider, } y + px = p^2 x^4$$

$$x\sqrt{p} = c \text{ or } x^2 p = c \text{ or } p = c/x^2$$

$$\text{Using (2) in (1) we have, } y + (c/x^2)x = (c^2/x^4)x^4$$

Thus $xy + c = c^2 x$ is the general solution.

Now, to obtain the singular solution, we differentiate this relation partially w.r.t c,

treating c as a parameter.

$$\text{That is, } 1 = 2cx \text{ or } c = 1/2x.$$

The general solution now becomes,

$$xy + \frac{1}{2x} = \frac{1}{4x^2} x$$

Thus $4x^2 y + 1 = 0$, is the singular solution.

3) Solve $y = p \sin p + \cos p$

Sol: $y = p \sin p + \cos p$

Differentiating w.r.t. x,

$$p = p \cos p \frac{dp}{dx} + \sin p \frac{dp}{dx} - \sin p \frac{dp}{dx}$$

$$\text{ie., } 1 = \cos p \frac{dp}{dx} \quad \text{or} \quad \cos p \, dp = dx$$

$$\Rightarrow \int \cos p \, dp = \int dx + c$$

$$\text{ie., } \sin p = x + c \quad \text{or} \quad x = \sin p - c$$

Thus we can say that $y = p \sin p + \cos p$ and $x = \sin p - c$ constitutes the general solution of the given d.e

$$\text{Note: } \sin p = x + c \Rightarrow p = \sin^{-1}(x + c).$$

We can as well substitute for p in (1) and present the solution in the form,

$$y = (x + c) \sin^{-1}(x + c) + \cos \sin^{-1}(x + c)$$

4) Obtain the general solution and singular solution of the equation

$$y = 2px + p^2y$$

Sol: The given equation is solvable for x and it can be written as

$$2x = \frac{y}{p} - py \dots \dots (1)$$

Differentiating w.r.t y we get

$$\frac{2}{p} = \frac{1}{p} - \frac{y}{p^2} \frac{dp}{dy} - p - y \frac{dp}{dy}$$

$$\Rightarrow \left(\frac{1}{p} + p \right) \left(1 + \frac{y}{p} \frac{dp}{dy} \right) = 0$$

Ignoring $\left(\frac{1}{p} + p \right)$ which does not contain $\frac{dp}{dy}$, this gives

$$1 + \frac{y}{p} \frac{dp}{dy} = 0 \quad \text{or} \quad \frac{dy}{y} + \frac{dp}{p} = 0$$

Integrating we get

$$yp = c \dots \dots (2)$$

substituting for p from 2 in (1)

$$y^2 = 2cx + c^2$$

5) Solve $p^2 + 2py \cot x = y^2$.

Sol: Dividing throughout by p^2 , the equation can be written as

$$\frac{y^2}{p^2} - \frac{2y}{p} \cot x = 1 \quad \text{adding } \cot^2 x \text{ to b.s}$$

$$\frac{y^2}{p^2} - \frac{2y}{p} \cot x + \cot^2 x = 1 + \cot^2 x$$

$$\text{or } \left(\frac{y}{p} - \cot x \right)^2 = \operatorname{cosec}^2 x$$

$$\Rightarrow \frac{y}{p} - \cot x = \pm \operatorname{cosec} x$$

$$\Rightarrow \frac{y}{dy/dx} = \cot x \pm \operatorname{cosec} x$$

$$\Rightarrow \frac{dy}{y} = \frac{\sin x}{\cos x + 1} dx \quad \text{and} \quad \frac{dy}{y} = \frac{\sin x}{\cos x - 1}$$

Integrating these two equations we get

$$y(\cos x + 1) = c_1 \quad \text{and} \quad y(\cos x - 1) = c_2$$

general solution is

$$y(\cos x + 1) - c_1 \quad y(\cos x - 1) - c_2 = 0$$

6) Solve: $p^2 - 4x^5 p - 12x^4 y = 0$, obtain the singular solution also..

Sol: The given equation is solvable for y only.

$$p^2 - 4x^5 p - 12x^4 y = 0 \quad \dots\dots\dots(1)_-$$

$$y = \frac{p^2 + 4x^5 p}{12x^4} = f(x, p)$$

Differentiating (1) w.r.t.x,

$$2p \frac{dp}{dx} + 4x^5 \frac{dp}{dx} + 20x^4 p - 12x^4 p - 48x^3 y = 0$$

$$\frac{dp}{dx} (2p + 4x^5) + 8x^3 (xp - \frac{p^2 + 4x^5 p}{2x^4}) = 0$$

$$(p + 2x^5) \frac{dp}{dx} = \frac{2p}{x} (p + 2x^5)$$

$$\frac{dp}{dx} - \frac{2p}{x} = 0$$

$$\Rightarrow \text{Integrating } \log \sqrt{p} - \log x = k$$

$$\Rightarrow p = c^2 x^2 \quad \therefore \text{equation (1) becomes}$$

$$c^4 + 4c^2 x^3 = 12y$$

Setting $c^2 = k$ the general solution becomes

$$k^2 + 4kx^3 = 12y$$

Differentiating w.r.t k partially we get

$$2k + 4x^3 = 0$$

Using $k = -2x^3$ in general solution we get

$$x^6 + 3y = 0 \text{ as the singular solution}$$

7) Solve $p^3 - 4xyp + 8y^2 = 0$ by solving for x .

Sol: The given equation is solvable for x only.

$$p^3 - 4xyp + 8y^2 = 0$$

$$x = \frac{p^3 + 8y^2}{4yp} = f(y, p)$$

Differentiating (1) w.r.t. y ,

$$3p^2 \frac{dp}{dy} - 4xy \frac{dp}{dy} - 4yp \cdot \frac{1}{p} - 4px + 16y = 0$$

$$\frac{dp}{dy} (3p^2 - 4xy) = 4px - 12y$$

$$\frac{dp}{dy} \left[3p^2 \frac{p^3 + 8y^2}{p} \right] = \left[\frac{p^3 + 8y^2}{y} - 12y \right]$$

$$\frac{dp}{dy} \left[\frac{2p^3 - 8y^2}{p} \right] = \frac{p^3 - 4y^2}{y}$$

$$\frac{2}{p} \frac{dp}{dy} (p^3 - 4y^2) = \frac{p^3 - 4y^2}{y}$$

$$\frac{2}{p} \frac{dp}{dy} = \frac{1}{y}$$

$$2 \log p = \log y + \log c$$

Using $P = \sqrt{cy}$ in (1) we have,

$$cy \sqrt{cy} - 4xy \sqrt{cy} + 8y^2 = 0$$

Dividing throughout by $y\sqrt{y} = y^{3/2}$ we have,

$$c\sqrt{c} - 4x\sqrt{c} + 8\sqrt{y} = 0$$

$$\sqrt{c}(c - 4x) = -8\sqrt{y}$$

Thus the general solution is $(c - 4x)^2 = 64y$

Clairaut's Equation

The equation of the form $y = px + f(p)$ is known as Clairaut's equation.

This being in the form $y = F(x, p)$, that is solvable for y , we differentiate (1) w.r.t. x

$$\therefore \frac{dy}{dx} = p = p + x \frac{dp}{dx} + f'(p) \frac{dp}{dx}$$

This implies that $\frac{dp}{dx} = 0$ and hence $p = c$

Using $p = c$ in (1) we obtain the general solution of Clairaut's equation in the form

$$y = cx + f(c)$$

1. **Solve:** $y = px + \frac{a}{p}$

Sol: The given equation is Clairaut's equation of the form $y = px + f(p)$, whose general solution is $y = cx + f(c)$

Thus the general solution is $y = cx + \frac{a}{c}$

Singular solution

Differentiating partially w.r.t c the above equation we have,

$$0 = x - \frac{a}{c^2}$$

$$c = \sqrt{\frac{a}{x}}$$

Hence $y = cx + (a/c)$ becomes,

$$y = \sqrt{a/x} \cdot x + a\sqrt{x/a}$$

Thus $y^2 = 4ax$ is the singular solution.

2. **Modify the following equation into Clairaut's form. Hence obtain the associated general and singular solutions** $xp^2 - py + kp + a = 0$

$$\text{Sol: } xp^2 - py + kp + a = 0, \text{ by data}$$

$$\text{ie., } xp^2 + kp + a = py$$

$$\text{ie., } y = \frac{p(xp+k)+a}{p}$$

$$\text{ie., } y = px + \left(k + \frac{a}{p}\right)$$

Here (1) is in the Clairaut's form $y=px+f(p)$ whose general solution is $y = cx + f(c)$

$$\text{Thus the general solution is } y = cx + \left(k + \frac{a}{c}\right)$$

Now differentiating partially w.r.t c we have,

$$0 = x - \frac{a}{c^2}$$

$$c = \sqrt{a/x}$$

Hence the general solution becomes,

$$y - k = 2\sqrt{ax}$$

Thus the singular solution is $(y - k)^2 = 4ax$.

Remark: We can also obtain the solution in the method: solvable for y .

3. Solve the equation $(px - y)(py + x) = 2p$ by reducing into Clairaut's form, taking the substitutions $X = x^2$, $Y = y^2$

$$\text{Sol: } X = x^2 \Rightarrow \frac{dX}{dx} = 2x$$

$$Y = y^2 \Rightarrow \frac{dY}{dy} = 2y$$

$$\text{Now, } p = \frac{dy}{dx} = \frac{dy}{dY} \frac{dY}{dX} \frac{dX}{dx} \text{ and let } p = \frac{dY}{dx}$$

$$\text{ie., } p = \frac{1}{2y} \cdot P \cdot 2x$$

$$\text{ie., } p = \frac{\sqrt{X}}{\sqrt{Y}} P$$

$$\text{Consider } (px - y)(py + x) = 2p$$

$$\text{ie., } \left[\frac{\sqrt{X}}{\sqrt{Y}} P\sqrt{X} - \sqrt{Y} \right] \left[\frac{\sqrt{X}}{\sqrt{Y}} P\sqrt{Y} - \sqrt{X} \right] = 2 \frac{\sqrt{X}}{\sqrt{Y}} P$$

$$\text{ie., } (PX - Y)(P+1) = 2P$$

ie., $Y = PX - \frac{2P}{P+1}$ is in the Clairaut's form and hence the associated general solution is

$$Y = cX - \frac{2c}{c+1}$$

Thus the required general solution of the given equation is $y^2 = cx^2 - \frac{2c}{c+1}$

4) Solve $px - y - py + x = a^2 p$, use the substitution $X = x^2, Y = y^2$.

$$\text{Sol: Let } X = x^2 \Rightarrow \frac{dX}{dx} = 2x$$

$$Y = y^2 \Rightarrow \frac{dY}{dy} = 2y$$

$$\text{Now, } p = \frac{dy}{dx} = \frac{dy}{dY} \frac{dY}{dX} \frac{dX}{dx} \text{ and let } P = \frac{dY}{dX}$$

$$P = \frac{1}{2y} \cdot p \cdot 2x \text{ or } p = \frac{x}{y} P$$

$$p = \frac{\sqrt{X}}{\sqrt{Y}} P$$

$$\text{Consider } (px - y)(py + x) = 2p$$

$$\left[\frac{\sqrt{X}}{\sqrt{Y}} P\sqrt{X} - \sqrt{Y} \right] \left[\frac{\sqrt{X}}{\sqrt{Y}} P\sqrt{Y} + \sqrt{X} \right] = 2 \frac{\sqrt{X}}{\sqrt{Y}} P$$

$$(PX - Y)(P+1) = 2P$$

$$Y = PX - \frac{2P}{P+1}$$

Is in the Clairaut's form and hence the associated general solution is

$$Y = cX - \frac{2c}{c+1}$$

Thus the required general solution of the given equation is $y^2 = cx^2 - \frac{2c}{c+1}$

5) Obtain the general solution and singular solution of the Clairaut's equation $xp^3 - yp^2 + 1 = 0$ Sol: The given equation can be written as

$$y = \frac{xp^3 + 1}{p^2} \Rightarrow y = px + \frac{1}{p^2} \text{ is in the Clairaut's form } y = px + f(p)$$

whose general solution is $y = cx + f(c)$

Thus general solution is $y = cx + \frac{1}{c^2}$

Differentiating partially w.r.t. c we get

$$0 = x - \frac{2}{c^3} \Rightarrow c = \left(\frac{2}{x}\right)^{1/3}$$

Thus general solution becomes

$$y = \left(\frac{2}{x}\right)^{1/3} x + \left(\frac{x}{2}\right)^{2/3} \Rightarrow 2^{2/3} y = 3x^{2/3}$$

or $4y^3 = 27x^2$

MODULE – 3

PARTIAL DIFFERENTIAL EQUATIONS

Introduction:

Many problems in vibration of strings, heat conduction, electrostatics involve two or more variables. Analysis of these problems leads to partial derivatives and equations involving them. In this unit we first discuss the formation of PDE analogous to that of formation of ODE. Later we discuss some methods of solving PDE.

Definitions:

An equation involving one or more derivatives of a function of two or more variables is called a **partial differential equation**.

The **order** of a PDE is the order of the highest derivative and the **degree** of the PDE is the degree of highest order derivative after clearing the equation of fractional powers.

A PDE is said to be linear if it is of first degree in the dependent variable and its partial derivative.

In each term of the PDE contains either the dependent variable or one of its partial derivatives, the PDE is said to be **homogeneous**. Otherwise it is said to be a **nonhomogeneous** PDE.

- Formation of pde by eliminating the arbitrary constants
- Formation of pde by eliminating the arbitrary functions

Solutions to first order first degree pde of the type

$$Pp + Qq = R$$

Formation of pde by eliminating the arbitrary constants:

$$(1) \quad 2z = \frac{x^2}{a^2} + \frac{y^2}{b^2} \quad \text{Solve:}$$

Sol: Differentiating (i) partially with respect to x and y,

$$2 \frac{\partial z}{\partial x} = \frac{2x}{a^2} \quad \text{or} \quad \frac{1}{a^2} = \frac{1}{x} \frac{\partial z}{\partial x} = \frac{p}{x}$$

$$\frac{2\partial z}{\partial y} = \frac{2y}{b^2} \quad \text{or} \quad \frac{1}{b^2} = \frac{1}{y} \frac{\partial z}{\partial y} = \frac{q}{y}$$

Substituting these values of $1/a^2$ and $1/b^2$ in (i), we get

$$(2) z = (x^2 + a)(y^2 + b)$$

Sol: Differentiating the given relation partially

$$(x-a)^2 + (y-b)^2 + z^2 = k^2 \dots (i)$$

Differentiating (i) partially w. r. t. x and y,

$$(x-a) + z \frac{\partial z}{\partial x} = 0, (y-b) + z \frac{\partial z}{\partial y} = 0$$

Substituting for (x- a) and (y- b) from these in (i), we get

$$z^2 \left[1 + \left(\frac{\partial z}{\partial x} \right)^2 + \left(\frac{\partial z}{\partial y} \right)^2 \right] = k^2 \text{ This is the required partial differential equation.}$$

$$(3) z = ax + by + cxy \dots (i)$$

Sol: Differentiating (i) partially w.r.t. xy, we get

$$\frac{\partial z}{\partial x} = a + cy \dots (ii)$$

$$\frac{\partial z}{\partial y} = b + cx \dots (iii)$$

It is not possible to eliminate a, b, c from relations (i)-(iii).

Partially differentiating (ii),

$$\frac{\partial^2 z}{\partial x \partial y} = c \text{ Using this in (ii) and (iii)}$$

$$a = \frac{\partial z}{\partial x} - y \frac{\partial^2 z}{\partial x \partial y}$$

$$b = \frac{\partial z}{\partial y} - x \frac{\partial^2 z}{\partial x \partial y}$$

Substituting for a, b, c in (i), we get

$$z = x \left[\frac{\partial z}{\partial x} - y \frac{\partial^2 z}{\partial x \partial y} \right] + y \left[\frac{\partial z}{\partial y} - x \frac{\partial^2 z}{\partial x \partial y} \right] + xy \frac{\partial^2 z}{\partial x \partial y}$$

$$z = x \frac{\partial z}{\partial x} + y \frac{\partial z}{\partial y} - xy \frac{\partial^2 z}{\partial x \partial y}$$

$$(5) \frac{x^2}{a^2} + \frac{y^2}{b^2} + \frac{z^2}{c^2} = 1$$

Sol: Differentiating partially w.r.t. x,

$$\frac{2x}{a^2} + \frac{2z}{c^2} \frac{\partial z}{\partial x} = 0, \text{ or } \frac{x}{a^2} = -\frac{z}{c^2} \frac{\partial z}{\partial x}$$

Differentiating this partially w.r.t. x, we get

$$\frac{1}{a^2} = -\frac{1}{c^2} \left\{ \left(\frac{\partial z}{\partial x} \right)^2 + z \frac{\partial^2 z}{\partial x^2} \right\} \text{ or } \frac{c^2}{a^2} = - \left\{ \left(\frac{\partial z}{\partial x} \right)^2 + z \frac{\partial^2 z}{\partial x^2} \right\}$$

: Differentiating the given equation partially w.r.t. y twice we get

$$\frac{z}{y} \frac{\partial z}{\partial y} = \left(\frac{\partial z}{\partial y} \right)^2 + z \frac{\partial^2 z}{\partial y^2} \quad \frac{z}{x} \frac{\partial z}{\partial x} = \left(\frac{\partial z}{\partial x} \right)^2 + z \frac{\partial^2 z}{\partial x^2}$$

Is the required p. d. e..

Note:

As another required partial differential equation.

P.D.E. obtained by elimination of arbitrary constants need not be not unique

Formation of p d e by eliminating the arbitrary functions:

$$1) z = f(x^2 + y^2)$$

Sol: Differentiating z partially w.r.t. x and y,

$$p = \frac{\partial z}{\partial x} = f'(x^2 + y^2) \cdot 2x, q = \frac{\partial z}{\partial y} = f'(x^2 + y^2) \cdot 2y$$

$p/q = x/y$ or $yp - xq = 0$ is the required pde

$$(2) z = f(x + ct) + g(x - ct)$$

Sol: Differentiating z partially with respect to x and t ,

$$\frac{\partial z}{\partial x} = f'(x + ct) + g'(x - ct), \frac{\partial^2 z}{\partial x^2} = f''(x + ct) + g''(x - ct)$$

Thus the pde is

$$\frac{\partial^2 z}{\partial t^2} + \frac{\partial^2 z}{\partial x^2} = 0$$

$$(3) x + y + z = f(x^2 + y^2 + z^2)$$

Sol: Differentiating partially w.r.t. x and y

$$1 + \frac{\partial z}{\partial x} = f'(x^2 + y^2 + z^2) \left[2x + 2z \frac{\partial z}{\partial x} \right]$$

$$1 + \frac{\partial z}{\partial y} = f'(x^2 + y^2 + z^2) \left[2y + 2z \frac{\partial z}{\partial y} \right]$$

$$2f'(x^2 + y^2 + z^2) = \frac{1 + (\partial z / \partial x)}{x + z(\partial z / \partial x)} = \frac{1 + (\partial z / \partial y)}{y + z(\partial z / \partial y)}$$

$$(y - z) \frac{\partial z}{\partial x} + (z - x) \frac{\partial z}{\partial y} = x - y \text{ is the required pde}$$

$$(4) z = f(xy/z)$$

Sol: Differentiating partially w.r.t. x and y

$$\frac{\partial z}{\partial x} = f' \left(\frac{xy}{z} \right) \left\{ \frac{y}{z} - \frac{xy}{z^2} \frac{\partial z}{\partial x} \right\}$$

$$\frac{\partial z}{\partial y} = f' \left(\frac{xy}{z} \right) \left\{ \frac{x}{z} - \frac{xy}{z^2} \frac{\partial z}{\partial y} \right\}$$

$$f'\left(\frac{xy}{z}\right) = \frac{\partial z / \partial x}{(y/z)\{1-(x/z)(\partial z / \partial x)\}} = \frac{\partial z / \partial y}{(x/z)\{1-(y/z)(\partial z / \partial y)\}}$$

$$x \frac{\partial z}{\partial x} = y \frac{\partial z}{\partial y}$$

or $xp = yq$ is the required pde.

$$(5) z = y^2 + 2f(1/x + \log y)$$

$$\text{Sol: } \frac{\partial z}{\partial y} = 2y + 2f'(1/x + \log y) \left\{ \frac{1}{y} \right\}$$

$$\frac{\partial z}{\partial x} = 2f'(1/x + \log y) \left\{ -\frac{1}{x^2} \right\}$$

$$2f'(1/x + \log y) = -x^2 \frac{\partial z}{\partial x} = y \left(\frac{\partial z}{\partial y} - 2y \right)$$

$$\text{Hence } x^2 \frac{\partial z}{\partial x} + y \frac{\partial z}{\partial y} = 2y^2$$

$$(6) Z = x\phi(y) + y\psi(x)$$

$$\text{Sol: } \frac{\partial z}{\partial x} = \phi(y) + y\psi'(x); \frac{\partial z}{\partial y} = x\phi'(y) + \psi(x)$$

Substituting $\phi'(y)$ and $\psi'(x)$

$$xy \frac{\partial^2 z}{\partial x \partial y} = x \frac{\partial z}{\partial x} + y \frac{\partial z}{\partial y} - [x\phi(y) + y\psi(x)]$$

$$xy \frac{\partial^2 z}{\partial x \partial y} = x \frac{\partial z}{\partial x} + y \frac{\partial z}{\partial y} - z \quad \text{is the required pde.}$$

7) Form the partial differential equation by eliminating the arbitrary functions from

$$z = f(y-2x) + g(2y-x) \quad (\text{Dec 2011})$$

Sol: By data, $z = f(y-2x) + g(2y-x)$

$$p = \frac{\partial z}{\partial x} = -2f'(y-2x) - g'(2y-x)$$

$$q = \frac{\partial z}{\partial y} = f'(y-2x) + 2g'(2y-x)$$

$$r = \frac{\partial^2 z}{\partial x^2} = 4f''(y-2x) + g''(2y-x) \dots \dots \dots (1)$$

$$s = \frac{\partial^2 z}{\partial x \partial y} = -2f''(y-2x) - 2g''(2y-x) \dots \dots \dots (2)$$

$$t = \frac{\partial^2 z}{\partial y^2} = f''(y-2x) + 4g''(2y-x) \dots \dots \dots (3)$$

$$(1) \times 2 + (2) \Rightarrow 2r + s = 6f''(y-2x) \dots \dots \dots (4)$$

$$(2) \times 2 + (3) \Rightarrow 2s + t = -3f''(y-2x) \dots \dots \dots (5)$$

Now dividing (4) by (5) we get

$$\frac{2r + s}{2s + t} = -2 \quad \text{or} \quad 2r + 5s + 2t = 0$$

$$\text{Thus} \quad 2 \frac{\partial^2 z}{\partial x^2} + 5 \frac{\partial^2 z}{\partial x \partial y} + 2 \frac{\partial^2 z}{\partial y^2} = 0 \text{ is the required PDE}$$

LAGRANGE'S FIRST ORDER FIRST DEGREE PDE: Pp+Qq=R

(1)

Solve: $yzp + zxq = xy$.

$$\text{Sol:} \quad \frac{dx}{yz} = \frac{dy}{zx} = \frac{dz}{xy}$$

Subsidiary equations are

From the first two and the last two terms, we get, respectively

$$\frac{dx}{y} = \frac{dy}{x} \text{ or } xdx - ydy = 0 \quad \text{and} \quad \frac{dy}{z} = \frac{dz}{y} \text{ or } ydy - zdz = 0.$$

Integrating we get $x^2 - y^2 = a$, $y^2 - z^2 = b$.

Hence, a general solution is

$$\Phi(x^2 - y^2, y^2 - z^2) = 0$$

(2) Solve: $y^2p - xyq = x(z - 2y)$

$$\text{Sol: } \frac{dx}{y^2} = \frac{dy}{-xy} = \frac{dz}{x(z - 2y)}$$

From the first two ratios we get

$$x^2 + y^2 = a \quad \text{from the last ratio two we get}$$

$$\frac{dz}{dy} + \frac{z}{y} = 2$$

from the last ratio two we get

$$\frac{dz}{dy} + \frac{z}{y} = 2 \quad \text{ordinary linear differential equation hence}$$

$$yz - y^2 = b$$

$$\text{solution is } \Phi(x^2 + y^2, yz - y^2) = 0$$

(3) Solve : $z(xp - yq) = y^2 - x^2$

$$\text{Sol: } \frac{dx}{zx} = \frac{dy}{-zy} = \frac{dz}{y^2 - x^2}$$

$$\frac{dx}{x} = \frac{dy}{-y}, \text{ or } xdy + ydx = 0 \text{ or } d(xy) = 0,$$

on integration, yields $xy = a$

$$x dx + y dy + z dz = 0 \quad x^2 + y^2 + z^2 = b$$

Hence, a general solution of the given equation

$$\Phi(x, y, x^2 + y^2 + z^2) = 0$$

$$(4) \text{ Solve: } \frac{y-z}{yz} p + \frac{z-x}{zx} q = \frac{x-y}{xy}$$

$$\text{Sol: } \frac{yz}{y-z} dx = \frac{zx}{z-x} dy = \frac{xy}{x-y} dz$$

$$x dx + y dy + z dz = 0 \quad \dots(i)$$

Integrating (i) we get

$$x^2 + y^2 + z^2 = a$$

$$y dx + zx dy + xy dz = 0 \quad \dots(ii)$$

Dividing (ii) throughout by xyz and then integrating,

we get $xyz = b$

$$\Phi(x^2 + y^2 + z^2, xyz) = 0$$

$$(5) (x+2z)p + (4zx-y)q = 2x^2 + y$$

$$\text{Sol: } \frac{dx}{x+2z} = \frac{dy}{4zx-y} = \frac{dz}{2x^2+y} \quad \dots(i)$$

Using multipliers $2x, -1, -1$ we obtain $2x dx - dy - dz = 0$

Using multipliers $y, x, -2z$ in (i), we obtain

$y dx + x dy - 2z dz = 0$ which on integration yields

$$xy - z^2 = b \quad \dots(iii)$$

5) Solve

$z_{xy} = \sin x \sin y$ for which $z_y = -2 \sin y$ when $x = 0$ and $z = 0$ when y is an odd multiple of $\frac{\pi}{2}$.

Sol: Here we first find z by integration and apply the given conditions to determine the arbitrary functions occurring as constants of integration.

The given PDF can be written as $\frac{\partial}{\partial x} \left(\frac{\partial z}{\partial y} \right) = \sin x \sin y$

Integrating w.r.t x treating y as constant,

$$\frac{\partial z}{\partial y} = \sin y \int \sin x dx + f(y) = -\sin y \cos x + f(y)$$

Integrating w.r.t y treating x as constant

$$z = -\cos x \int \sin y dy + \int f(y) dy + g(x)$$

$$z = -\cos x (-\cos y) + F(y) + g(x),$$

$$\text{where } F(y) = \int f(y) dy.$$

Thus $z = \cos x \cos y + F(y) + g(x)$

Also by data, $\frac{\partial z}{\partial y} = -2 \sin y$ when $x = 0$. Using this in (1)

$$-2 \sin y = (-\sin y) \cdot 1 + f(y) \quad (\cos 0 = 1)$$

$$\text{Hence } F(y) = \int f(y) dy = \int -\sin y dy = \cos y$$

With this, (2) becomes $z = \cos x \cos y + \cos y + g(x)$

Using the condition that $z = 0$ if $y = (2n+1)\frac{\pi}{2}$ in (3) we have

$$0 = \cos x \cos(2n+1)\frac{\pi}{2} + \cos x \cos(2n+1)\frac{\pi}{2} + g(x)$$

$$\text{But } \cos(2n+1)\frac{\pi}{2} = 0. \text{ and hence } 0 = 0 + 0 + g(x)$$

Thus the solution of the PDE is given by

$$z = \cos x \cos y + \cos y$$

Method of Separation of Variables

1) Solve by the method of variables $3u_x + 2u_y = 0$, given that $u(x, 0) = 4e^{-x}$

Sol: Given $3 \frac{\partial u}{\partial x} + 2 \frac{\partial u}{\partial y} = 0 \dots \dots \dots (1)$

Assume solution of (1) as

$$U=XY \text{ where } X=X(x); Y = Y(y)$$

$$3 \frac{\partial u}{\partial x}(xy) + 2 \frac{\partial u}{\partial y}(xy) = 0$$

$$\Rightarrow 3Y \frac{dX}{dx} + 2X \frac{dY}{dy} = 0 \Rightarrow \frac{3}{X} \frac{dX}{dx} = \frac{-2}{Y} \frac{dY}{dy}$$

$$\text{Let } \frac{3}{X} \frac{dX}{dx} = K \Rightarrow \frac{3dX}{X} = Kdx$$

$$\Rightarrow 3 \log X = Kx + c_1 \Rightarrow \log X = \frac{Kx}{3} + c_1$$

$$\Rightarrow X = e^{\frac{Kx}{3} + c_1}$$

$$\text{Let } \frac{-2}{Y} \frac{dY}{dy} = K \Rightarrow \frac{dY}{Y} = \frac{-Kdy}{2}$$

$$\Rightarrow \log Y = \frac{-Kdy}{2} + c_2 \Rightarrow Y = e^{\frac{-Ky}{2} + c_2}$$

Substituting (2) & (3) in (1)

$$U = e^{K\left(\frac{x}{3} - \frac{y}{2}\right) + c_1 + c_2}$$

$$\text{Also } u(x, 0) = 4e^{-x}$$

$$\text{i.e., } 4e^{-x} = Ae^{K\left(\frac{2x}{6}\right)} \Rightarrow 4e^{-x} = Ae^{\frac{Kx}{3}}$$

Comparing we get $A = 4$ & $K = -3$

$$U = 4e^{-3\left(\frac{x}{3} - \frac{y}{2}\right)} \text{ is required solution.}$$

2) Solve by the method of variables $4 \frac{\partial u}{\partial x} + \frac{\partial u}{\partial y} = 3u$, given that $u(0, y) = 2e^{5y}$

$$\text{Sol: Given } 4 \frac{\partial u}{\partial x} + \frac{\partial u}{\partial y} = 3u$$

Assume solution of (1) as

$$u = XY \text{ where } X = X(x); Y = Y(y)$$

$$4 \frac{\partial}{\partial x}(XY) + \frac{\partial}{\partial y}(XY) = 3XY$$

$$\Rightarrow 4Y \frac{dX}{dx} + X \frac{dY}{dy} = 3XY \Rightarrow \frac{4}{X} \frac{dX}{dx} + \frac{1}{Y} \frac{dY}{dy} = 3$$

$$\text{Let } \frac{4}{X} \frac{dX}{dx} = k, \quad 3 - \frac{1}{Y} \frac{dY}{dy} = k$$

Separating variables and integrating we get

$$\Rightarrow \log X = \frac{kx}{4} + c_1, \quad \log Y = 3 - k y + c_2$$

$$\Rightarrow X = e^{\frac{kx}{4} + c_1} \quad \text{and} \quad Y = e^{3 - k y + c_2}$$

$$\text{Hence } u = XY = e^{c_1 + c_2} e^{\frac{kx}{4} + 3 - k y} = A e^{\frac{kx}{4} + 3 - k y} \quad \text{where } A = e^{c_1 + c_2}$$

$$\text{put } x = 0 \text{ and } u = 2e^{5y}$$

The general solution becomes

$$2e^{5y} = A e^{3 - k y} \Rightarrow A = 2 \text{ and } k = -2$$

\therefore Particular solution is

$$u = 2e^{\frac{-x}{2} + 5y}$$

APPLICATION OF PARTIAL DIFFERENTIAL EQUATIONS:

ONE DIMENSIONAL HEAT EQUATION:

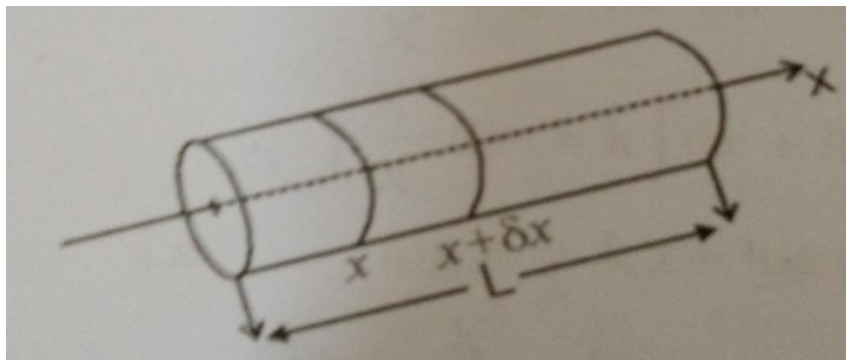

Consider a heat conducting homogeneous rod of length L placed along x -axis. One end of the rod at $x=0$ (Origin) and the other end of the rod at $x=L$.

Assume that the rod as constant density ρ and uniform cross section A. Also assume that the rod is insulated laterally and therefore heat flows only in the x direction. The rod is sufficiently thin so that the temperature is same at all points of any cross sectional area of the rod.

Let $u(x, t)$ be the temperature of the cross section at the point x at any time t.

The amount of heat crossing any section of the rod per second depends on the area A of the cross section, the thermal conductivity k of the material of rod and the temperature gradient $\frac{\partial u}{\partial x}$

i.e., the rate of change of temperature with respect to distance normal to the area.

Therefore q_1 the quantity of heat flowing into the cross section at a distance x in unit

time is $q_1 = -kA \left(\frac{\partial u}{\partial x} \right)_x$ per second

Negative sign appears because heat flows in the direction of decreasing temperature (as x increases u decreases)

q_2 the quantity of heat flowing out of the cross section at a distance $x + \delta x$ (i.e, the rate of heat flow at cross section $x + \delta x$)

$q_2 = -kA \left(\frac{\partial u}{\partial x} \right)_{x+\delta x}$ per second

The rate of change of heat content in segment of the rod between x and $x + \delta x$ must be equal to net heat flow into this segment of the rod is

$$q_1 - q_2 = kA \left[\left(\frac{\partial u}{\partial x} \right)_{x+\delta x} - \left(\frac{\partial u}{\partial x} \right)_x \right] \text{ per second} \dots \dots \dots (1)$$

But the rate of increase of heat in the rod

$$s\rho A\delta x \frac{\partial u}{\partial t} \dots \dots \dots (2)$$

Where S is the specific heat, ρ the density of material.

From (1) & (2)

$$s\rho A\delta x \frac{\partial u}{\partial t} = kA \left[\left(\frac{\partial u}{\partial x} \right)_{x+\delta x} - \left(\frac{\partial u}{\partial x} \right)_x \right]$$

$$\text{or } s\rho \frac{\partial u}{\partial t} = k \left[\frac{\left(\frac{\partial u}{\partial x} \right)_{x+\delta x} - \left(\frac{\partial u}{\partial x} \right)_x}{\delta x} \right]$$

Taking limit as $\delta x \rightarrow 0$, we have

$$s\rho \frac{\partial}{\partial t} = k \frac{\partial^2 u}{\partial x^2} \text{ or } \frac{\partial u}{\partial t} = \frac{k}{s\rho} \frac{\partial^2 u}{\partial x^2}$$

$$\text{or } \frac{\partial u}{\partial t} = c^2 \frac{\partial^2 u}{\partial x^2} \dots\dots\dots(3) \text{ where } c^2 = \frac{k}{s\rho}$$

Is known as diffusivity constant.

Equation (3) is the one dimensional heat equation which is second order homogenous and parabolic type.

Various possible solutions of standard p.d.es by the method of separation of variables.

We need to obtain the solution of the ODEs by taking the constant k equal to

- i) Zero
- ii) positive: $k=+p^2$
- iii) negative: $k=-p^2$

Thus we obtain three possible solutions for the associated p.d.e

Various possible solutions of the one dimensional heat equation $u_t=c^2u_{xx}$ by the method of separation of variables.

Consider $\frac{\partial u}{\partial t} = c^2 \frac{\partial^2 u}{\partial x^2}$

Let $u= XT$ where $X=X(x),T=T(t)$ be the solution of the PDE

Hence the PDE becomes

$$\frac{\partial XT}{\partial t} = c^2 \frac{\partial^2 XT}{\partial x^2} \text{ or } X \frac{dT}{dt} = c^2 \frac{d^2 X}{dx^2}$$

Dividing by c^2XT we have $\frac{1}{c^2T} \frac{dT}{dt} = \frac{1}{X} \frac{d^2X}{dx^2}$

Equating both sides to a common constant k we have

$$\frac{1}{X} \frac{d^2X}{dx^2} = k \quad \text{and} \quad \frac{1}{c^2T} \frac{dT}{dt} = k$$

$$\frac{d^2X}{dx^2} - kX = 0 \quad \text{and} \quad \frac{dT}{dt} - c^2kT = 0$$

$$D^2 - k X = 0 \quad \text{and} \quad D - c^2k T = 0$$

Where $D^2 = \frac{d^2}{dx^2}$ in the first equation and $D = \frac{d}{dt}$ in the second equation

Case (i) : let $k=0$

AEs are $m=0$ and $m^2=0$ and $m=0,0$ are the roots

Solutions are given by

$$T = c_1 e^{0t} = c_1 \quad \text{and} \quad X = c_2 x + c_3 \quad e^{0x} = c_2 x + c_3$$

Hence the solution of the PDE is given by

$$U = XT = c_1 (c_2 x + c_3)$$

Or $u(x,t) = Ax + B$ where $c_1 c_2 = A$ and $c_1 c_3 = B$

Case (ii) let k be positive say $k = +p^2$

AEs are $m - c^2 p^2 = 0$ and $m^2 - p^2 = 0$

$$m = c^2 p^2 \quad \text{and} \quad m = +p$$

Solutions are given by

$$T = c'_1 e^{c^2 p^2 t} \quad \text{and} \quad X = c'_2 e^{px} + c'_3 e^{-px}$$

Hence the solution of the PDE is given by

$$u = XT = c'_1 e^{c^2 p^2 t} \cdot (c'_2 e^{px} + c'_3 e^{-px})$$

Or $u(x,t) = c_1 e^{c^2 p^2 t} (A e^{px} + B e^{-px})$ where $c_1 c_2 = A$ and $c_1 c_3 = B$

Case (iii): let k be negative say $k = -p^2$

AEs are $m + c^2 p^2 = 0$ and $m^2 + p^2 = 0$

$m = -c^2 p^2$ and $m = \pm ip$

solutions are given by

$$T = c_1 e^{-c^2 p^2 t} \quad \text{and} \quad X = c_2 \cos px + c_3 \sin px$$

Hence the solution of the PDE is given by

$$u = XT = c_1 e^{-c^2 p^2 t} (c_2 \cos px + c_3 \sin px)$$

$$u(x,t) = e^{-c^2 p^2 t} (A \cos px + B \sin px)$$

1. Solve the Heat equation $\frac{\partial u}{\partial t} = c^2 \frac{\partial^2 u}{\partial x^2}$ given that $u(0,t)=0, u(l,t)=0$ and $u(x,0) = 100x/l$

$$\text{Soln: } b_n = \frac{2}{l} \int_0^l \frac{100x}{l} \sin \frac{n\pi x}{l} dx = \frac{200}{l^2} \int_0^l x \sin \frac{n\pi x}{l} dx$$

$$b_n = \frac{200}{l^2} \left[\frac{x \cdot -\cos \frac{n\pi x}{l}}{n\pi/l} - 1 \frac{-\sin \frac{n\pi x}{l}}{n\pi/l^2} \right]_0^l$$

$$b_n = \frac{200}{l^2} \cdot \frac{-1}{n\pi} l \cos n\pi = -\frac{200(-1)^n}{n\pi} = \frac{200(-1)^{n+1}}{n\pi}$$

The required solution is obtained by substituting this value of b_n

$$\text{Thus } u(x,t) = \sum_{n=1}^{\infty} \frac{200(-1)^{n+1}}{n\pi} e^{-n^2 \pi^2 c^2 t} \sin \frac{n\pi x}{l}$$

2. Obtain the solution of the heat equation $\frac{\partial u}{\partial t} = c^2 \frac{\partial^2 u}{\partial x^2}$ given that $u(0,t)=0, u(l,t)$ and

$$u(x,0) = f(x) \text{ where } f(x) = \begin{cases} \frac{2Tx}{l} & \text{in } 0 \leq x \leq \frac{l}{2} \\ \frac{2T}{l} (l-x) & \text{in } \frac{l}{2} \leq x \leq l \end{cases}$$

Soln: $b_n = \frac{2}{l} \int_0^l f(x) \sin \frac{n\pi x}{l} dx$

$$b_n = \frac{2}{l} \left[\int_0^{\frac{l}{2}} \frac{2Tx}{l} \sin \frac{n\pi x}{l} dx + \int_{\frac{l}{2}}^l \frac{2T}{l} (l-x) \sin \frac{n\pi x}{l} dx \right]$$

$$= \frac{4T}{l} \left[\int_0^{\frac{l}{2}} x \sin \frac{n\pi x}{l} dx + \int_{\frac{l}{2}}^l (l-x) \sin \frac{n\pi x}{l} dx \right]$$

$$b_n = \frac{8T}{n^2 \pi^2} \sin \frac{n\pi}{2}$$

The required solution is obtained by substituting this value of b_n

Thus $u(x,t) = \frac{8T}{\pi^2} \sum_{n=1}^{\infty} \frac{1}{n^2} \sin \frac{n\pi}{2} e^{-\frac{n^2 \pi^2 c^2 t}{l^2}} \sin \frac{n\pi x}{l}$

3. Solve the heat equation $\frac{\partial u}{\partial t} = \frac{\partial^2 u}{\partial x^2}$ with the boundary conditions $u(0,t)=0, u(l,t)$ and $u(x,0) = 3 \sin \pi x$

Soln: $u(x,t) = e^{-p^2 t} (A \cos px + B \sin px) \dots \dots \dots (1)$

Consider $u(0,t)=0$ now 1 becomes

$$0 = e^{-p^2 t} (A) \text{ thus } A=0$$

Consider $u(l,t)=0$ using $A=0$ (1) becomes

$$0 = e^{-p^2 t} (B \sin pl)$$

Since $B \neq 0, \sin pl = 0$ or $p = n\pi$

$$u(x,t) = e^{-n^2\pi^2c^2t} (B \sin n\pi x)$$

$$\text{In general } u(x,t) = \sum_{n=1}^{\infty} b_n e^{-n^2\pi^2c^2t} \sin n\pi x$$

Consider $u(x,0) = 3 \sin n\pi x$ and we have

$$3 \sin n\pi x = b_1 \sin \pi x + b_2 \sin 2\pi x + b_3 \sin 3\pi x$$

Comparing both sides we get $b_1 = 3, b_2 = 0, b_3 = 0$

We substitute these values in the expanded form and then get

$$u(x,t) = 3e^{-\pi^2 t} (\sin \pi x)$$

ONE DIMENSIONAL WAVE EQUATION:

Consider a tightly stretched elastic string of length l stretched between two points O and A and displaced slightly from its equilibrium position OA. Taking O as origin and OA as x axis and a perpendicular line through O as Y- axis. We shall find the displacement y a function of the distance x and the time t .

We shall obtain the equation of motion of string under the following assumptions.

- i) The string is perfectly flexible and offers no resistance to bending
- ii) Points on the string move only in the vertical direction, there is no motion in the horizontal direction. The motion takes place entirely in the X Y plane .
- iii) Gravitational forces on the string is neglected.

Let m be the mass per unit length of the string. Consider the motion of an element PQ of length δs . Since the string does not offer resistance to bending, the tensions T_1

At P and T_2 at Q are tangential to the curve.

Since there is no motion in the horizontal direction, some of the forces in the horizontal direction must be zero.

$$\text{i.e., } -T_1 \cos \alpha + T_2 \cos \beta = 0 \text{ or } T_1 \cos \alpha = T_2 \cos \beta = T = \text{constant} \dots (1)$$

Since gravitational force on the string is neglected , the only two forces acting on the string are the vertical components of tension - $T_1 \sin \alpha$ at P and $T_2 \sin \beta$ at Q with up[ward direction takes as positive.

Mass of an element PQ is $m \delta s$. By Newton’s second law of motion , the equation of motion in the vertical direction is

Resultant of forces = mass *acceleration

$$T_2 \sin \beta - T_1 \sin \alpha = m \delta s \frac{\partial^2 y}{\partial t^2} \dots\dots\dots(2).$$

$$\frac{2}{1} \text{ gives } \frac{T_2 \sin \beta}{T_2 \cos \beta} - \frac{T_1 \sin \alpha}{T_1 \cos \alpha} = \frac{m \delta s}{T} \frac{\partial^2 y}{\partial t^2}$$

$$\text{or } \tan \beta - \tan \alpha = \frac{m \delta s}{T} \frac{\partial^2 y}{\partial t^2}$$

$$\frac{\partial^2 y}{\partial t^2} = \frac{T}{m \delta s} \tan \beta - \tan \alpha$$

$$\frac{\partial^2 y}{\partial t^2} = \frac{T}{m \delta s} \left[\left(\frac{\partial y}{\partial x} \right)_{x+\delta x} - \left(\frac{\partial y}{\partial x} \right)_x \right]$$

($\because \delta s = \delta x$ to a first approximation and $\tan \alpha, \tan \beta$ are the slopes of the curve of the string at x and $x + \delta x$)

$$\frac{\partial^2 y}{\partial t^2} = \frac{T}{m} \left[\frac{\left(\frac{\partial y}{\partial x} \right)_{x+\delta x} - \left(\frac{\partial y}{\partial x} \right)_x}{\delta x} \right]$$

Taking Limit as $\delta x \rightarrow 0$

$$\frac{\partial^2 y}{\partial t^2} = \frac{T}{m} \frac{\partial^2 y}{\partial x^2} \quad \text{or} \quad \frac{\partial^2 y}{\partial t^2} = c^2 \frac{\partial^2 y}{\partial x^2} \dots\dots\dots(3) \quad \text{where } c^2 = \frac{T}{m}$$

Which is the partial differential equation giving the transverse vibrations of the string .

Equation (3) is the one dimensional wave equation which is second order homogenous and parabolic type.

Various possible solutions of the one dimensional wave equation $u_{tt} = c^2 u_{xx}$ by the method of separation of variables.

Consider $\frac{\partial^2 u}{\partial t^2} = c^2 \frac{\partial^2 u}{\partial x^2}$

Let $u = XT$ where $X = X(x), T = T(t)$ be the solution of the PDE

Hence the PDE becomes

$$\frac{\partial^2 XT}{\partial t^2} = c^2 \frac{\partial^2 XT}{\partial x^2} \text{ or } X \frac{d^2 T}{dt^2} = c^2 \frac{d^2 X}{dx^2}$$

Dividing by $c^2 XT$ we have $\frac{1}{c^2 T} \frac{d^2 T}{dt^2} = \frac{1}{X} \frac{d^2 X}{dx^2}$

Equating both sides to a common constant k we have

$$\frac{1}{X} \frac{d^2 X}{dx^2} = k \quad \text{and} \quad \frac{1}{c^2 T} \frac{d^2 T}{dt^2} = k$$

$$\frac{d^2 X}{dx^2} - kX = 0 \quad \text{and} \quad \frac{d^2 T}{dt^2} - c^2 kT = 0$$

$$D^2 - k X = 0 \quad \text{and} \quad D^2 - c^2 k T = 0$$

Where $D^2 = \frac{d^2}{dx^2}$ in the first equation and $D^2 = \frac{d^2}{dt^2}$ in the second equation

Case(i) : let $k=0$

AEs are $m=0$ and $m^2=0$ and $m=0,0$ are the roots

Solutions are given by

$$T = c_1 e^{0t} = c_1 \text{ and } X = c_2 x + c_3 \quad e^{0x} = c_2 x + c_3$$

Hence the solution of the PDE is given by

$$U = XT = c_1 (c_2 x + c_3)$$

Or $u(x,t) = Ax + B$ where $c_1 c_2 = A$ and $c_1 c_3 = B$

Case (ii) let k be positive say $k = +p^2$

AEs are $m^2 - c^2 p^2 = 0$ and $m^2 - p^2 = 0$

$$m = c^2 p^2 \text{ and } m = +p$$

Solutions are given by

$$T = c_1' e^{c^2 p^2 t} \text{ and } X = c_2' e^{px} + c_3' e^{-px}$$

Hence the solution of the PDE is given by

$$u = XT = c_1' e^{c^2 p^2 t} \cdot (c_2' e^{px} + c_3' e^{-px})$$

Or $u(x,t) = c_1' e^{c^2 p^2 t} (A' e^{px} + B' e^{-px})$ where $c_1' c_2' = A'$ and $c_1' c_3' = B'$

Case (iii): let k be negative say $k = -p^2$

$$\text{AEs are } m + c^2 p^2 = 0 \text{ and } m^2 + p^2 = 0$$

$$m = -c^2 p^2 \text{ and } m = \pm ip$$

Solutions are given by

$$T = c_1'' e^{-c^2 p^2 t} \text{ and } X = c_2'' \cos px + c_3'' \sin px$$

Hence the solution of the PDE is given by

$$u = XT = c_1'' e^{-c^2 p^2 t} \cdot (c_2'' \cos px + c_3'' \sin px)$$

$$u(x,t) = e^{-c^2 p^2 t} (A'' \cos px + B'' \sin px)$$

1. Solve the wave equation $u_{tt} = c^2 u_{xx}$ subject to the conditions $u(t,0) = 0$, $u(l,t) = 0$,

$$\frac{\partial u}{\partial t} \Big|_{x=0} = 0 \text{ and } u(x,0) = u_0 \sin^3(x/l)$$

$$\text{Soln: } u(x,t) = \sum_{n=1}^{\infty} b_n \sin \frac{n\pi x}{l} \cos \frac{n\pi ct}{l}$$

Consider $u(x,0) = u_0 \sin^3(x/l)$

$$u(x,0) = \sum_{n=1}^{\infty} b_n \sin \frac{n\pi x}{l}$$

$$u_0 \sin^3 \frac{\pi x}{l} = \sum_{n=1}^{\infty} b_n \sin \frac{n\pi x}{l}$$

$$u_0 \left[\frac{3}{4} \sin^3 \frac{\pi x}{l} - \frac{1}{4} \sin \frac{3\pi x}{l} \right] = \sum_{n=1}^{\infty} b_n \sin \frac{n\pi x}{l}$$

$$\frac{3u_0}{4} \sin \frac{\pi x}{l} - \frac{u_0}{4} \sin \frac{3\pi x}{l} = b_1 \sin \frac{\pi x}{l} + b_2 \sin \frac{2\pi x}{l} + b_3 \sin \frac{3\pi x}{l}$$

comparing both sides we get

$$b_1 = \frac{3u_0}{4}, b_2 = 0, b_3 = \frac{-u_0}{4}, b_4 = 0, b_5 = 0,$$

Thus by substituting these values in the expanded form we get

$$u(x,t) = \frac{3u_0}{4} \sin \frac{\pi x}{l} \cos \frac{\pi ct}{l} - \frac{u_0}{4} \sin \frac{3\pi x}{l} \cos \frac{3\pi ct}{l}$$

2. Solve the wave equation $u_{tt} = c^2 u_{xx}$ subject to the conditions $u(t,0)=0, u(l,t)=0,$
 $\frac{\partial u}{\partial t} (x,0) = 0$ when $t=0$ and $u(x,0) = f(x)$

$$\text{Soln: } u(x,t) = \sum_{n=1}^{\infty} b_n \sin \frac{n\pi x}{l} \cos \frac{n\pi ct}{l}$$

Consider $u(x,0)=f(x)$ then we have

$$\text{Consider } u(x,0) = \sum_{n=1}^{\infty} b_n \sin \frac{n\pi x}{l}$$

$$F(x) = \sum_{n=1}^{\infty} b_n \sin \frac{n\pi x}{l}$$

The series in RHS is regarded as the sine half range Fourier series of $f(x)$ in $(0,l)$ and hence

$$b_n = \frac{2}{l} \int_0^l f(x) \sin \frac{n\pi x}{l} dx$$

Thus we have the required solution in the form

$$u(x,t) = \sum_{n=1}^{\infty} b_n \sin \frac{n\pi x}{l} \cos \frac{n\pi ct}{l}$$

MODULE-4

INTEGRAL CALCULUS

DOUBLE INTEGRAL

The double integral of a function $f(x, y)$ over a region D in R^2 is denoted by $\iint_D f(x, y) dx dy$

Let $f(x, y)$ be a continuous function in R^2 defined on a closed rectangle

$$R = \{(x, y) / a \leq x \leq b \text{ and } c \leq y \leq d\}$$

For any fixed $x \in [a, b]$ consider the integral $\int_c^d f(x, y) dy$.

The value of this integral depends on x and we get a new function of x . This can be integrated depends on x and, we get $\int_a^b \left[\int_c^d f(x, y) dy \right] dx$. This is called an “**iterated integral**”.

Similarly, we can define another

$$\int_c^d \left[\int_a^b f(x, y) dx \right] dy$$

For continuous function $f(x, y)$, we have

$$\iint_R f(x, y) dx dy = \int_a^b \left[\int_c^d f(x, y) dy \right] dx = \int_c^d \left[\int_a^b f(x, y) dx \right] dy$$

If $f(x, y)$ is continuous on a bounded region S and S is given by

$S = \{(x, y) / a \leq x \leq b \text{ and } \phi_1(x) \leq y \leq \phi_2(x)\}$, where ϕ_1 and ϕ_2 are two continuous functions on $[a, b]$ then

$$\iint_S f(x, y) dx dy = \int_a^b \left[\int_{\phi_1(x)}^{\phi_2(x)} f(x, y) dy \right] dx$$

The iterated integral in the R.H.S. is also written in the form

$$\int_a^b dx \int_{\phi_1(x)}^{\phi_2(x)} f(x, y) dy$$

Similarly, if $S = \{(x, y) / c \leq y \leq d$
and $\phi_1(y) \leq x \leq \phi_2(y)\}$

then
$$\iint_S f(x, y) dx dy = \int_c^d \left[\int_{\phi_1(y)}^{\phi_2(y)} f(x, y) dx \right] dy$$

If S cannot be written in neither of the above two forms we divide S into finite number of subregions such that each of the subregions can be represented in one of the above forms and we get the double integral over S by adding the integrals over these subregions.

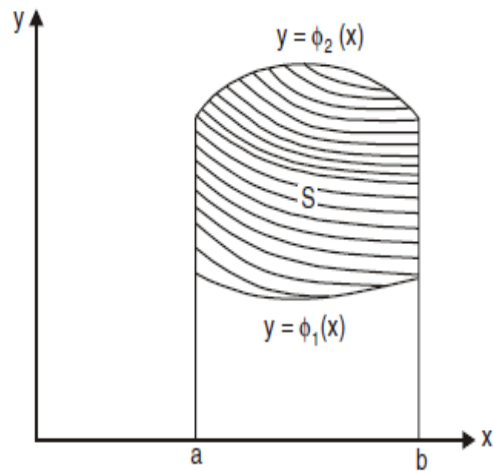

Fig. 3.1

PROBLEMS:

1. Evaluate: $I = \int_0^1 \int_0^2 xy^2 dy dx.$

Solution

$$\begin{aligned}
 I &= \int_0^1 \left[\int_0^2 xy^2 dy \right] dx \\
 &= \int_0^1 \left[\frac{xy^3}{3} \right]_0^2 dx && \text{(Integrating w.r.t. } y \text{ keeping } x \text{ constant)} \\
 &= \frac{1}{3} \int_0^1 8x dx \\
 &= \frac{1}{3} \left[\frac{8x^2}{2} \right]_0^1 = \frac{4}{3}.
 \end{aligned}$$

2. Evaluate: $\int_0^1 \int_1^2 xy \, dy \, dx$.

Solution. Let I be the given integral

$$\begin{aligned} \text{Then,} \quad I &= \int_0^1 x \left\{ \int_1^2 y \, dy \right\} dx \\ &= \int_0^1 x \cdot \left[\frac{y^2}{2} \right]_1^2 dx = \frac{3}{2} \int_0^1 x \, dx = \frac{3}{4}. \end{aligned}$$

5. Evaluate: $\int_{-c}^c \int_{-b}^b \int_{-a}^a (x^2 + y^2 + z^2) \, dz \, dy \, dx$.

$$\text{Solution} \quad I = \int_{x=-c}^c \int_{y=-b}^b \int_{z=-a}^a (x^2 + y^2 + z^2) \, dz \, dy \, dx$$

Integrating w.r.t. z , x and y – constant.

$$\begin{aligned} &= \int_{x=-c}^c \int_{y=-b}^b \left[x^2 z + y^2 z + \frac{z^3}{3} \right]_{z=-a}^a dy \, dx \\ &= \int_{x=-c}^c \int_{y=-b}^b \left[x^2(a+a) + y^2(a+a) + \left(\frac{a^3}{3} + \frac{a^3}{3} \right) \right] dy \, dx \\ &= \int_{x=-c}^c \int_{y=-b}^b \left(2ax^2 + 2ay^2 + \frac{2a^3}{3} \right) dy \, dx \end{aligned}$$

Integrating w.r.t. y , x – constant.

$$\begin{aligned} &= \int_{x=-c}^c \left[2ax^2 y + \frac{2ay^3}{3} + \frac{2a^3}{3} y \right]_{y=-b}^b dx \\ &= \int_{x=-c}^c \left[2ax^2(b+b) + \frac{2a}{3}(b^3+b^3) + \frac{2a^3}{3}(b+b) \right] dx \\ &= \int_{x=-c}^c \left[4ax^2 b + \frac{4ab^3}{3} + \frac{4a^3 b}{3} \right] dx \\ &= \left[4ab \left(\frac{x^3}{3} \right) + \frac{4ab^3}{3}(x) + \frac{4a^3 b}{3}(x) \right]_{-c}^c \\ &= 4ab \left(\frac{2c^3}{3} \right) + \frac{4ab^3}{3} \cdot (2c) + \frac{4a^3 b}{3} (2c) \\ &= \frac{8abc^3}{3} + \frac{8ab^3 c}{3} + \frac{8a^3 bc}{3} \\ I &= \frac{8abc}{3} (a^2 + b^2 + c^2). \end{aligned}$$

Evaluation of a Double Integral by Changing the Order of Integration

In the evaluation of the double integrals sometimes we may have to change the order of integration so that evaluation is more convenient. If the limits of integration are variables then change in the order of integration changes the limits of integration. In such cases a rough idea of the region of integration is necessary.

Evaluation of a Double Integral by Change of Variables

Sometimes the double integral can be evaluated easily by changing the variables.

Suppose x and y are functions of two variables u and v .

i.e., $x = x(u, v)$ and $y = y(u, v)$ and the Jacobian

$$J = \frac{\partial(x, y)}{\partial(u, v)} = \begin{vmatrix} \frac{\partial x}{\partial u} & \frac{\partial x}{\partial v} \\ \frac{\partial y}{\partial u} & \frac{\partial y}{\partial v} \end{vmatrix} \neq 0$$

Then the region A changes into the region R under the transformations

$$x = x(u, v) \text{ and } y = y(u, v)$$

$$\text{Then } \iint_A f(x, y) dx dy = \iint_R f(u, v) J du dv$$

$$\text{If } x = r \cos \theta, y = r \sin \theta$$

$$J = \frac{\partial(x, y)}{\partial(r, \theta)} = \begin{vmatrix} \frac{\partial x}{\partial r} & \frac{\partial x}{\partial \theta} \\ \frac{\partial y}{\partial r} & \frac{\partial y}{\partial \theta} \end{vmatrix} = \begin{vmatrix} \cos \theta & -r \sin \theta \\ \sin \theta & r \cos \theta \end{vmatrix} = r$$

$$\therefore \iint_A f(x, y) dx dy = \iint_R F(r, \theta) r dr d\theta. \quad \dots(1)$$

Applications to Area and Volume

1. $\iint_R dx dy = \text{Area of the region } R \text{ in the Cartesian form.}$

2. $\iint_R r \cdot dr d\theta = \text{Area of the region } R \text{ in the polar form.}$

3. $\iiint_V dx dy dz = \text{Volume of a solid.}$

4. Volume of a solid (in polars) obtained by the revolution of a curve enclosing an area A about the initial line is given by

$$V = \iint_A 2\pi r^2 \sin \theta \cdot dr d\theta.$$

5. If $z = f(x, y)$ be the equation of a surface S then the surface area is given by

$$\iint_A \sqrt{1 + \left(\frac{\partial z}{\partial x}\right)^2 + \left(\frac{\partial z}{\partial y}\right)^2} dx dy$$

Type 1. Evaluation over a given region

1. Evaluate $\iint_R xy \, dx \, dy$ where R is the triangular region bounded by the axes of coordinates and the line $\frac{x}{a} + \frac{y}{b} = 1$.

Solution. R is the region bounded by $x = 0$, $y = 0$ being the coordinates axes and $\frac{x}{a} + \frac{y}{b} = 1$ being the straight line through $(0, a)$ and $(0, b(1 - \frac{x}{a}))$

when x is held fixed and y varies from 0 to $b(1 - \frac{x}{a})$

$$\therefore \frac{x}{a} + \frac{y}{b} = 1$$

$$\Rightarrow \frac{y}{b} = 1 - \frac{x}{a}$$

$$\Rightarrow y = b\left(1 - \frac{x}{a}\right)$$

$$\begin{aligned} \therefore \iint_R xy \, dx \, dy &= \int_{x=0}^a \left\{ \int_{y=0}^{b(1-\frac{x}{a})} xy \, dy \right\} dx \\ &= \int_0^a x \cdot \left[\frac{y^2}{2} \right]_0^{b(1-\frac{x}{a})} dx \\ &= \int_0^a \left\{ x \cdot \frac{b^2}{2} \left(1 - \frac{x}{a}\right)^2 \right\} dx \\ &= \frac{b^2}{2} \int_0^a \left(x - 2\frac{x^2}{a} + \frac{x^3}{a^2} \right) dx \\ &= \frac{b^2}{2} \left[\frac{x^2}{2} - \frac{2x^3}{3a} + \frac{x^4}{4a^2} \right]_0^a \\ &= \frac{b^2}{2} \left[\frac{a^2}{2} - \frac{2}{3}a^2 + \frac{1}{4}a^2 \right] \\ &= \frac{a^2b^2}{24} \end{aligned}$$

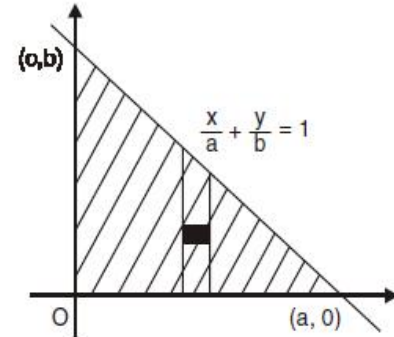

Fig. 3.2

2. Evaluate $\iint xy \, dx \, dy$ over the area in the first quadrant bounded by the circle $x^2 + y^2 = a^2$.

Solution

$$\iint xy \, dx \, dy = \int_{x=0}^a \left[\int_{y=0}^{\sqrt{a^2-x^2}} xy \, dy \right] dx$$

$$= \int_0^a x \cdot \left[\frac{y^2}{2} \right]_0^{\sqrt{a^2-x^2}} dx$$

$$= \int_0^a x \left(\frac{a^2-x^2}{2} \right) dx$$

$$= \frac{1}{2} \int_0^a (a^2x - x^3) dx$$

$$= \frac{1}{2} \left[a^2 \frac{x^2}{2} - \frac{x^4}{4} \right]_0^a$$

$$= \frac{1}{2} \left[\frac{a^4}{2} - \frac{a^4}{4} \right] = \frac{a^4}{8}$$

$$\begin{cases} \because x^2 + y^2 = a^2 \\ \Rightarrow y^2 = a^2 - x^2 \\ y = \sqrt{a^2 - x^2} \end{cases}$$

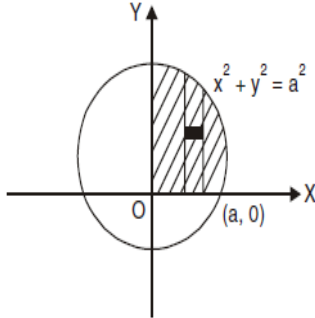

Fig. 3.3

Type 2. Evaluation of a double integral by changing the order of integration

1. Change the order of integration and hence evaluate $\int_0^a \int_0^{2\sqrt{ax}} x^2 \, dy \, dx$.

Solution

$$y = 2\sqrt{ax}$$

$$\Rightarrow y^2 = 4ax$$

when $x = a$ on $y^2 = 4ax$, $y^2 = 4a^2$

$$\Rightarrow y = \pm 2a$$

So, on $y = 2\sqrt{ax}$, $y = 2a$ when $x = a$

The integral is over the shaded region.

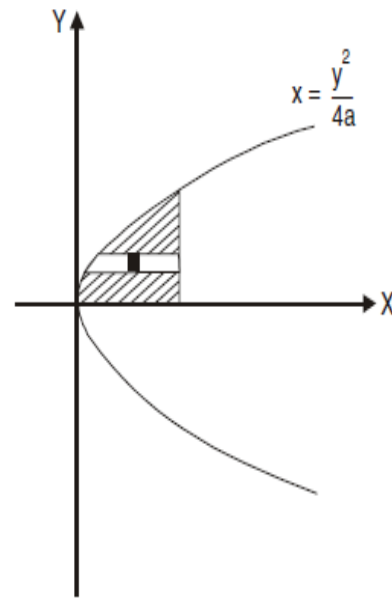
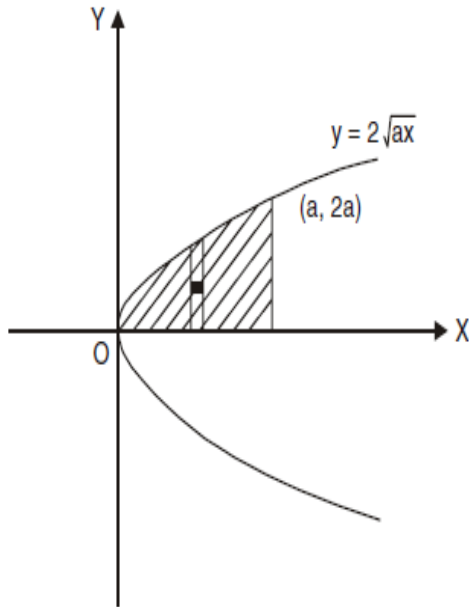

$$\int_0^a \int_0^{2\sqrt{ax}} x^2 dy dx = \int_{y=0}^{2a} \int_{x=\frac{y^2}{4a}}^a x^2 dx dy$$

(By changing the order)

$$= \int_0^{2a} \left[\frac{x^3}{3} \right]_{\frac{y^2}{4a}}^a dy$$

$$= \int_0^{2a} \left(\frac{a^3}{3} - \frac{y^6}{192 a^3} \right) dy$$

$$= \left[\frac{a^3}{3} y - \frac{y^7}{192 a^3 \times 7} \right]_0^{2a}$$

$$= \frac{2a^4}{3} - \frac{2^7 a^4}{192 \times 7}$$

$$= a^4 \left(\frac{2}{3} - \frac{2}{21} \right) = \frac{4}{7} a^4.$$

2. Change the order of integration and hence evaluate $\int_0^1 \int_x^{\sqrt{2-x^2}} \frac{x}{\sqrt{x^2+y^2}} dy dx$.

Solution $y = \sqrt{2-x^2}$

$\Rightarrow y^2 = 2 - x^2$

$\Rightarrow x^2 + y^2 = 2$

This circle and $y = x$ meet if $x^2 + x^2 = 2$

$\therefore 2x^2 = 2 \Rightarrow x = 1$

So, (1, 1) is the meeting point.

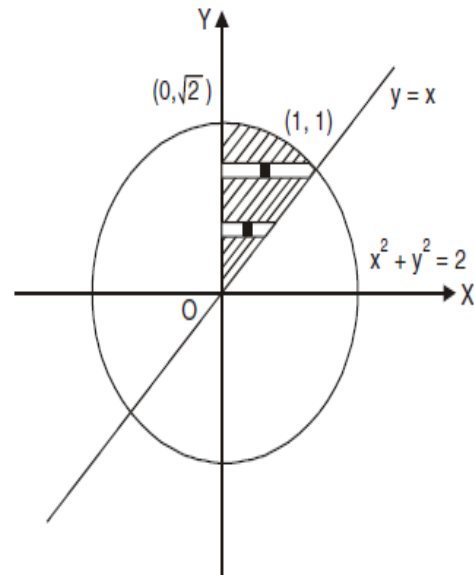

Now
$$I = \int_0^1 \int_x^{\sqrt{2-x^2}} \frac{x}{\sqrt{x^2+y^2}} dy dx$$

$$= \int_{y=0}^{\sqrt{2}} \int_{x=0}^{\phi(y)} \frac{x}{\sqrt{x^2+y^2}} dx dy$$

where $\phi(y) = \begin{cases} y & \text{for } 0 \leq y \leq 1 \\ \sqrt{2-y^2} & \text{for } 1 \leq y \leq \sqrt{2} \end{cases}$

(Note that $x = \phi(y)$ is the R.H.S. boundary of the shaded region)

So, the required integral is

$$I = \int_{y=0}^1 \int_{x=0}^y \frac{x}{\sqrt{x^2+y^2}} dx dy + \int_{y=1}^{\sqrt{2}} \int_{x=0}^{\sqrt{2-y^2}} \frac{x}{\sqrt{x^2+y^2}} dx dy$$

$$= \int_0^1 [x^2 + y^2]_0^y dy + \int_1^{\sqrt{2}} [\sqrt{x^2 + y^2}]_0^{\sqrt{2-y^2}} dy$$

$$= \int_0^1 (\sqrt{2} y - y) dy + \int_1^{\sqrt{2}} (\sqrt{2} - y) dy$$

$$\begin{aligned}
 &= \left[(\sqrt{2} - 1) \frac{y^2}{2} \right]_0^1 + \left[\sqrt{2}y - \frac{y^2}{2} \right]_1^{\sqrt{2}} \\
 &= \frac{\sqrt{2} - 1}{2} + \sqrt{2}(\sqrt{2} - 1) - \left(\frac{2}{2} - \frac{1}{2} \right) \\
 &= 1 - \frac{1}{\sqrt{2}}.
 \end{aligned}$$

Type 3. Evaluation by changing into polars

1. Evaluate $\int_0^\infty \int_0^\infty e^{-(x^2+y^2)} dx dy$ by changing to polar coordinates.

Solution. In polars we have $x = r \cos \theta$, $y = r \sin \theta$

$$\therefore x^2 + y^2 = r^2 \text{ and } dx dy = r dr d\theta$$

Since x, y varies from 0 to ∞

r also varies from 0 to ∞

In the first quadrant ' θ '
varies from 0 to $\pi/2$

Thus

$$I = \int_{\theta=0}^{\pi/2} \int_{r=0}^{\infty} e^{-r^2} r dr d\theta$$

Put

$$r^2 = t \quad \therefore r dr = \frac{dt}{2}$$

t also varies from 0 to ∞

$$\begin{aligned}
 I &= \int_{\theta=0}^{\pi/2} \int_{t=0}^{\infty} e^{-t} \frac{dt}{2} d\theta \\
 &= \frac{1}{2} \int_{\theta=0}^{\pi/2} [-e^{-t}]_0^\infty d\theta \\
 &= \frac{-1}{2} \int_0^{\pi/2} (0 - 1) d\theta \\
 &= +\frac{1}{2} \int_0^{\pi/2} 1 \cdot d\theta \\
 &= \frac{+1}{2} [\theta]_0^{\pi/2} = \frac{+1}{2} \cdot \frac{\pi}{2} = \frac{\pi}{4}.
 \end{aligned}$$

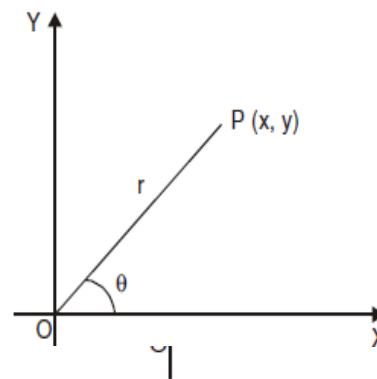

2. Evaluate $\int_0^a \int_0^{\sqrt{a^2-y^2}} y \sqrt{x^2+y^2} dx dy$ by changing into polars.

Solution
$$I = \int_{y=0}^a \int_{x=0}^{\sqrt{a^2-y^2}} y \sqrt{x^2+y^2} dx dy$$

$x = \sqrt{a^2 - y^2}$ or $x^2 + y^2 = a^2$ is a circle with centre origin and radius a . Since, y varies from 0 to a the region of integration is the first quadrant of the circle.

In polars, we have $x = r \cos \theta$, $y = r \sin \theta$

$$\therefore x^2 + y^2 = r^2$$

$$\text{i.e., } r^2 = a^2$$

$$\Rightarrow r = a$$

Also $x = 0$, $y = 0$ will give $r = 0$ and hence we can say that r varies from 0 to a . In the first quadrant θ varies from 0 to $\pi/2$, we know that $dx dy = r dr d\theta$

$$\begin{aligned} \therefore I &= \int_{r=0}^a \int_{\theta=0}^{\pi/2} r \sin \theta r r dr d\theta \\ &= \int_{r=0}^a \int_{\theta=0}^{\pi/2} r^3 \sin \theta dr d\theta \\ &= \int_{r=0}^a r^3 (-\cos \theta)_0^{\pi/2} dr \\ &= \int_0^a -r^3 (0 - 1) dr = \left[\frac{r^4}{4} \right]_0^a = \frac{a^4}{4} \\ I &= \frac{a^4}{4}. \end{aligned}$$

Triple Integrals:

The treatment of Triple integrals also known as volume integrals in R^3 is a simple and straight extension of the ideas in respect of double integrals.

Let $f(x,y,z)$ be continuous and single valued function defined over a region V of space. Let V be divided into sub regions $\delta v_1, \delta v_2, \dots, \delta v_n$ into n parts. Let (x_k, y_k, z_k) be any arbitrary point

within or on the boundary of the sub region δv_k . From the sum

$$s = \sum_{k=1}^n f(x_k, y_k, z_k) \delta v_k \dots\dots\dots(1)$$

If as $n \rightarrow \infty$ and the maximum diameter of every.

Sub region approaches zero the sum (1) has a limit then the limit is denoted by $\iiint_V f(x, y, z) dv$

This is called the triple integral of $f(x,y,z)$ over the region V .

For the purpose of evolution the above triple integral over the region V can be expressed as an iterated integral or repeated integral in the form

$$\iiint_V f(x, y, z) dx dy dz = \int_a^b \left[\int_{g(x)}^{h(x)} \left\{ \int_{\psi(x,y)}^{\phi(x,y)} f(x, y, z) dz \right\} dy \right] dx$$

Where $f(x,y,z)$ is continuous in the region V bounded by the surfaces $z = z = \psi(x, y)$, $z = \phi(x, y)$, $y = g(x)$, $y = h(x)$, $x = a$, $x = b$. the above integral indicates the three successive integration to be performed in the following order, first w.r.t z , keeping x and y as constant then w.r.t y keeping x as constant and finally w.r.t x .

Note:

- When an integration is performed w.r.t a variable that variable is eliminated completely from the remaining integral.
- If the limits are not constants the integration should be in the order in which dx, dy, dz is given in the integral.
- Evaluation of the integral may be performed in any order if all the limits are constants.
- If $f(x,y,z) = 1$ then the triple integral gives the volume of the region.

1. Evaluate $\int_0^1 \int_0^2 \int_1^2 xyz^2 dx dy dz$

$$\begin{aligned} \text{Sol : } \int_0^1 \int_0^2 \int_1^2 xyz^2 dx dy dz &= \int_0^1 \int_0^2 \left[\frac{x^2 y z^2}{2} \right]_1^2 dy dz \\ &= \int_0^1 \int_0^2 \left[2yz^2 - \frac{y^2 z^2}{2} \right]_1^2 dy dz \end{aligned}$$

$$\begin{aligned}
&= \int_0^1 \left[\frac{2y^2z^2}{2} - \frac{y^2z^2}{4} \right]_0^2 dz \\
&= \int_0^1 \left[y^2z^2 - \frac{y^2z^2}{4} \right]_0^2 dz \\
&= \int_0^1 \left[\frac{3y^2z^2}{4} \right]_0^2 dz \\
&= 1
\end{aligned}$$

2. Evaluate $\int_0^a \int_0^a \int_0^a (x^2 + y^2 + z^2) dx dy dz$

$$\begin{aligned}
\text{Sol: } \int_0^a \int_0^a \int_0^a (x^2 + y^2 + z^2) dx dy dz &= \int_0^a \int_0^a \left[\frac{x^3}{3} + y^2x + z^2x \right]_0^a dy dz \\
&= \int_0^a \int_0^a \left[\frac{a^3}{3} + y^2a + z^2a \right] dy dz \\
&= \int_0^a \left[\int_0^a \left[\frac{a^3}{3} + y^2a + z^2a \right] dy \right] dz \\
&= \int_0^a \left[\frac{a^3y}{3} + \frac{y^3a}{3} + z^2ay \right]_0^a dz \\
&= \int_0^a \left[\frac{a^4}{3} + \frac{a^4}{3} + a^2z^2 \right] dz \\
&= \left[\frac{a^4z}{3} + \frac{a^4z}{3} + \frac{a^2z^3}{3} \right]_0^a \\
&= \frac{a^5}{3} + \frac{a^5}{3} + \frac{a^5}{3} \\
&= a^5
\end{aligned}$$

3. Evaluate $\int_0^a \int_0^{\sqrt{a^2-x^2}} \int_0^{\sqrt{a^2-x^2-y^2}} x y z \, dx \, dy \, dz$

$$\begin{aligned}
 \text{Sol: } I &= \int_0^a \int_0^{\sqrt{a^2-x^2}} \left\{ \int_0^{\sqrt{a^2-x^2-y^2}} x y z \, dz \right\} dy \, dx \\
 &= \int_0^a \int_0^{\sqrt{a^2-x^2}} \left[\frac{xyz^2}{2} \right]_0^{\sqrt{a^2-x^2-y^2}} dy \, dx \\
 &= \int_0^a \int_0^{\sqrt{a^2-x^2}} \frac{xy}{2} (a^2 - x^2 - y^2) dy \, dx \\
 &= \frac{1}{2} \int_0^a \int_0^{\sqrt{a^2-x^2}} (xya^2 - x^3 y - xy^3) dy \, dx \\
 &= \frac{1}{2} \int_0^a \left[\frac{xy^2 a^2}{2} - \frac{x^3 y^2}{2} - \frac{xy^4}{4} \right]_0^{\sqrt{a^2-x^2}} dx \\
 &= \frac{1}{8} \int_0^a (a^4 x + x^5 - 2a^2 x^3) dx \\
 &= \frac{1}{8} \left[a^4 \frac{x^2}{2} + \frac{x^6}{6} - \frac{2a^2 x^4}{4} \right]_0^a = \frac{a^6}{48}
 \end{aligned}$$

4. Evaluate $\iiint_R xyz \, dx \, dy \, dz$ over the region R enclosed by the coordinate planes and the plane $x + y + z = 1$

Sol: In the given region, z varies from 0 to $1 - x - y$

For $z=0$, y varies from 0 to $1 - x$. For $y=0$, x varies from 0 to 1.

$$\begin{aligned}
 \therefore \iiint_R xyz \, dx \, dy \, dz &= \int_{x=0}^1 \int_{y=0}^{1-x} \int_{z=0}^{1-x-y} x y z \, dx \, dy \, dz \\
 &= \int_0^1 x \left\{ \int_0^{1-x} y \left[\frac{1}{2} (1-x-y)^2 \right] dy \right\} dx
 \end{aligned}$$

$$\begin{aligned}
&= \frac{1}{2} \int_0^1 x \left\{ \int_0^{1-x} [(1-x)^2 y - 2(1-x)y^2 + y^3] dy \right\} dx \\
&= \frac{1}{2} \int_0^1 x \left\{ \left[\frac{1}{2}(1-x)^2(1-x)^2 - \frac{2}{3}(1-x)(1-x)^3 + \frac{1}{4}(1-x)^4 \right] \right\} dx \\
&= \frac{1}{24} \int_0^1 x(1-x)^4 dx = \frac{1}{24} \left[-\frac{(1-x)^6}{30} \right]_0^1 \\
&= \frac{1}{720}
\end{aligned}$$

Change of variable in triple integrals

Computational work can often be reduced while evaluating triple integrals by changing the variables x, y, z to some new variables u, v, w , which related to x, y, z and which are such that the

$$\text{Jacobian } J = \frac{\partial(x, y, z)}{\partial(u, v, w)} = \begin{vmatrix} \frac{\partial x}{\partial u} & \frac{\partial x}{\partial v} & \frac{\partial x}{\partial w} \\ \frac{\partial y}{\partial u} & \frac{\partial y}{\partial v} & \frac{\partial y}{\partial w} \\ \frac{\partial z}{\partial u} & \frac{\partial z}{\partial v} & \frac{\partial z}{\partial w} \end{vmatrix} \neq 0$$

It can be proved that

$$\begin{aligned}
&\iiint_R f(x, y, z) dx dy dz \\
&= \iiint_R \phi(u, v, w) J du dv dw \dots \dots (1)
\end{aligned}$$

R is the region in which (x, y, z) vary and R^* is the corresponding region in which (u, v, w) vary and $\phi(u, v, w) = f(x(u, v, w), y(u, v, w), z(u, v, w))$

Once the triple integral wrt (x, y, z) is changed to triple integral wrt (u, v, w) by using the formula(1), the later integral may be evaluated by expressing it in terms of repeated integrals with appropriate limit of integration

Triple integral in cylindrical polar coordinates

Suppose (x,y,z) are related to three variables (R,ϕ, z) through the relation $x = R \cos \phi, y = R \sin \phi, z = z$ then R, ϕ, z are called cylindrical polar coordinates;

In this case,

$$J = \frac{\partial(x, y, z)}{\partial(R, \phi, z)} = \begin{vmatrix} \frac{\partial x}{\partial R} & \frac{\partial x}{\partial \phi} & \frac{\partial x}{\partial z} \\ \frac{\partial y}{\partial R} & \frac{\partial y}{\partial \phi} & \frac{\partial y}{\partial z} \\ \frac{\partial z}{\partial R} & \frac{\partial z}{\partial \phi} & \frac{\partial z}{\partial z} \end{vmatrix} = R$$

Hence $dx dy dz$ has to be changed to $R dR d\phi dz$

Thus we have

$$\begin{aligned} & \iiint_R f(x, y, z) dx dy dz \\ &= \iiint_R f(R \cos \phi, R \sin \phi, z) R dR d\phi dz \end{aligned}$$

R^* is the region in which (R, ϕ, z) vary, as (x, y, z) vary in R

$$\phi(R, \phi, z) = f(R \cos \phi, R \sin \phi, z)$$

Triple integral in spherical polar coordinates

Suppose (x,y,z) are related to three variables (r,θ, ϕ) through the relations

$x = r \sin \theta \cos \phi, y = r \sin \theta \sin \phi, z = r \cos \theta$. Then (r,θ, ϕ) are called spherical polar coordinates.

PROBLEMS:

- 1) If R is the region bounded by the planes $x=0, y=0, z=0, z=1$ and the cylinder $x^2 + y^2 = 1$. Evaluate the integral $\iiint_R xyz dx dy dz$ by changing it to cylindrical polar coordinates.

Sol: Let (R, ϕ, z) be cylindrical polar coordinates. In the given region, R varies from 0

to 1, ϕ varies from 0 to $\frac{\pi}{2}$ and z varies from 0 to 1.

$$\begin{aligned}
\iiint_R xyz dx dy dz &= \int_{R=0}^1 \int_{\phi=0}^{\frac{\pi}{2}} \int_{z=0}^1 (R \cos \phi)(R \sin \phi) z R dR d\phi dz \\
&= \int_0^1 R^3 dR \int_0^{\frac{\pi}{2}} \sin \phi \cos \phi \int_0^1 z dz \\
&= \frac{1}{4} \int_0^1 R^3 dR \left[\frac{-\cos 2\phi}{2} \right]_0^{\frac{\pi}{2}} \\
&= \frac{1}{4} \int_0^1 R^3 dR \\
&= \frac{1}{16}
\end{aligned}$$

- 2) Evaluate $\iiint_R xyz dx dy dz$ over the positive octant of the sphere by changing it to spherical polar coordinates.

Sol: In the region, r varies from 0 to a , θ varies from 0 to $\frac{\pi}{2}$ and ϕ varies from 0 to $\frac{\pi}{2}$.

The relations between Cartesian and spherical polar coordinates are

$$x = r \sin \theta \cos \phi, y = r \sin \theta \sin \phi, z = r \cos \theta \dots (1)$$

$$\text{Also } dx dy dz = r^2 \sin \theta dr d\theta d\phi$$

$$\text{We have } x^2 + y^2 + z^2 = a^2 \dots (2)$$

$$\begin{aligned}
\therefore \iiint_R xyz dx dy dz &= \int_{\theta=0}^{\frac{\pi}{2}} \int_{\phi=0}^{\frac{\pi}{2}} \int_{r=0}^a r \sin \theta \cos \phi r \sin \theta \sin \phi r \cos \theta r^2 \sin \theta dr d\theta d\phi \\
&= \int_{\theta=0}^{\frac{\pi}{2}} r^5 \sin^3 \theta \cos \theta \sin \phi dr d\theta d\phi \\
&= -\frac{a^6}{96} \cos \pi - \cos 0 \\
&= \frac{a^6}{48}
\end{aligned}$$

Application of double integrals:

Introduction: we now consider the use of double integrals for computing areas of plane and curved surfaces and volumes, which occur quite in science and engineering.

Computation of plane Areas:

Recall expression

$$\int_A f(x, y) dA = \iint_R f(x, y) dx dy = \int_a^b \int_{y_1(x)}^{y_2(x)} f(x, y) dy dx = \int_c^d \int_{x_1(y)}^{x_2(y)} f(x, y) dx dy$$

$$\int_A dA = \iint_R dx dy = \int_a^b \int_{y_1(x)}^{y_2(x)} dy dx = \int_c^d \int_{x_1(y)}^{x_2(y)} dx dy \dots \dots \dots (1)$$

The integral $\int_A dA$ represents the total area of the plane region R over which the iterated integral are taken. Thus (1) may be used to compute the area A. Note that dx dy is the plane area element dA in the Cartesian form.

Also $\iint_R dx dy = \iint_R r dr d\theta$, $r dr d\theta$ is the plane area element in polar form.

Area in Cartesian form

Let the curves AB and CD be $y_1 = f_1(x)$ and $y_2 = f_2(x)$. Let the ordinates AC and BD be $x=a$ and $x=b$. So the area enclosed by the two curves and $x=a$ and $x=b$ is ABCD. Let $p(x, y)$ and $q(x + \delta x, y + \delta y)$ two neighbouring points, then the area of the small rectangle PQ = $\delta x \delta y$

$$\text{Area of the vertical strip} = \lim_{\delta y \rightarrow 0} \sum_{y_1}^{y_2} \delta x \delta y = \delta x \int_{y_1}^{y_2} dy$$

Since δx the width of the strip is constant throughout, if we add all the strips from $x=a$ to $x=b$ we get

$$\text{The area ABCD} = \lim_{\delta y \rightarrow 0} \sum_a^b \delta x \int_{y_1}^{y_2} dy = \int_a^b dx \int_{y_1}^{y_2} dy$$

$$\text{Area} = \int_a^b \int_{y_1}^{y_2} dx dy$$

Area in Polar form:

1. Find the area of the ellipse $\frac{x^2}{a^2} + \frac{y^2}{b^2} = 1$ by double integration.

Soln: For the vertical strip PQ, y varies from y = 0 to $y = \frac{b}{a} \sqrt{a^2 - x^2}$ when the strip is slid from CB to A, x varies from x=0 to x=a

$$\text{Therefore Area of the ellipse} = 4 \text{ Area of CAB} = 4 \int_{x=0}^a \int_{y=0}^{\frac{b}{a} \sqrt{a^2 - x^2}} dy dx$$

$$= 4 \int_0^a \left\{ \int_0^{\frac{b}{a} \sqrt{a^2 - x^2}} dy \right\} dx = 4 \int_0^a \frac{b}{a} \sqrt{a^2 - x^2} dx$$

$$= 4 \int_0^a \frac{b}{a} \sqrt{a^2 - x^2} dx = 4 \frac{b}{a} \left[\frac{x \sqrt{a^2 - x^2}}{2} + \frac{a^2}{2} \sin^{-1} \left(\frac{x}{a} \right) \right]_0^a$$

$$= 4 \frac{b}{a} \left[\frac{a^2}{2} \sin^{-1} 1 \right] = 4 \frac{b}{a} \cdot \frac{a^2}{2} \cdot \frac{\pi}{2} = \pi ab$$

2. Find the area between the parabolas $y^2=4ax$ and $x^2 = 4ay$

Soln: We have $y^2=4ax$ (1)

and $x^2 = 4ay$(2).

Solving (1) and (2) we get the point of intersections (0,0) and (4a,4a) . The shaded portion in the figure is the required area divide the arc into horizontal strips of width δy

x varies from $\frac{y^2}{4a}$ to $\sqrt{4ay}$ and then y varies from O, y=0 to A, y=4a .

Therefore the required area is

$$\int_0^{4a} dy \int_{\frac{y^2}{4a}}^{\sqrt{4ay}} dx = \int_0^{4a} dy \left[x \right]_{\frac{y^2}{4a}}^{\sqrt{4ay}}$$

$$= \int_0^{4a} \left[\sqrt{4ay} - \frac{y^2}{4a} \right] dy = \left[\sqrt{4a} \cdot \frac{y^{\frac{3}{2}}}{\frac{3}{2}} - \frac{1}{4a} \frac{y^3}{3} \right]_0^{4a}$$

$$= \left[\frac{4\sqrt{a}}{3} 4a^{\frac{3}{2}} - \frac{1}{12a} 4a^3 \right]$$

$$= \frac{32}{3} a^2 - \frac{16}{3} a^2 = \frac{16}{3} a^2$$

Computation of surface area (using double integral):

The double integral can be made use in evaluating the surface area of a surface.

Consider a surface S in space. Let the equation of the surface S be $z=f(x,y)$. It can be that surface area of this surface is

$$\text{Given by } s = \iint_A \left[1 + \left(\frac{\partial z}{\partial x} \right)^2 + \left(\frac{\partial z}{\partial y} \right)^2 \right]^{\frac{1}{2}} dx dy$$

Where A the region representing the projection of S on the xy-plane.

Note that (x,y) vary over A as (x,y,z) vary over S.

Similarly if B and C projection of S on the yz-plane and zx-plane respectively, then

$$s = \iint_B \left[1 + \left(\frac{\partial z}{\partial y} \right)^2 + \left(\frac{\partial z}{\partial z} \right)^2 \right]^{\frac{1}{2}} dy dz$$

and

$$s = \iint_C \left[1 + \left(\frac{\partial z}{\partial x} \right)^2 + \left(\frac{\partial z}{\partial z} \right)^2 \right]^{\frac{1}{2}} dz dx$$

1) Find the surface area of the sphere $x^2+y^2+z^2=a^2$.

Soln: the required surface arc is twice the surface area of the upper part of the given sphere, whose equation is

$$z = a^2 - x^2 - y^2 \quad z > 0$$

$$\text{this, gives, } \frac{\partial z}{\partial x} = a^2 - x^2 - y^2^{-\frac{1}{2}} - 2x$$

$$= \frac{-x}{a^2 - x^2 - y^2^{\frac{1}{2}}}$$

$$\text{similarly, } \frac{\partial z}{\partial y} = \frac{y}{a^2 - x^2 - y^2^{\frac{1}{2}}}$$

$$\therefore 1 + \left(\frac{\partial z}{\partial x}\right)^2 + \left(\frac{\partial z}{\partial y}\right)^2 = \frac{a^2}{a^2 - x^2 - y^2}$$

hence, the, required, surface, area, is

$$s = 2 \iint_A \left[1 + \left(\frac{\partial z}{\partial x}\right)^2 + \left(\frac{\partial z}{\partial y}\right)^2 \right]^{\frac{1}{2}} dx dy = 2 \iint_A \left\{ \frac{a^2}{a^2 - x^2 - y^2} \right\}^{\frac{1}{2}} dx dy$$

Where A the projection of the sphere on the xy-plane . we note that this projection is the area bounded by circle $x^2 + y^2 = a^2$. hence in A , θ varies from 0 to 2π

And r varies from 0 to a, where (r, θ) are the polar coordinates. put $x = r \cos \theta$, $y = r \sin \theta$ $dx dy = r dr d\theta$

$$\begin{aligned} \therefore s &= 2 \int_{\theta=0}^{2\pi} \int_{r=0}^a \frac{a}{\sqrt{a^2 - r^2}} r dr d\theta = 2 \int_0^{2\pi} d\theta \times \int_0^a \frac{r}{\sqrt{a^2 - r^2}} r dr \\ &= 2a \int_0^{2\pi} d\theta \left[-\sqrt{a^2 - r^2} \right]_0^a = 2a \int_0^{2\pi} d\theta \left[\frac{2}{3} \right] = 4\pi a^2 \end{aligned}$$

2) Find the surface area of the portion of the cylinder $x^2 + z^2 = a^2$ which lies inside the cylinder $x^2 + y^2 = a^2$.

Soln: Let s_1 be the cylinder $x^2 + z^2 = a^2$ and s_2 be the cylinder $x^2 + y^2 = a^2$ for the cylinder

$$s_1 = \frac{\partial z}{\partial x} = -\frac{x}{z}, \quad \frac{\partial z}{\partial y} = 0$$

$$\text{so that, } 1 + \left(\frac{\partial z}{\partial x}\right)^2 + \left(\frac{\partial z}{\partial y}\right)^2 = 1 + \frac{x^2}{z^2} + 0 = \frac{z^2 + x^2}{z^2} = \frac{a^2}{a^2 - x^2}$$

The required surface area is twice the surface area of the upper part of the cylinder S_1 which lies inside the cylinder $x^2 + y^2 = a^2$. Hence the required surface area is

$$s = 2 \iint_A \left[1 + \left(\frac{\partial z}{\partial x} \right)^2 + \left(\frac{\partial z}{\partial y} \right)^2 \right]^{\frac{1}{2}} dA = 2 \iint_A \frac{a}{\sqrt{a^2 - x^2}} dA,$$

Where A is the projection of the cylinder S_1 on the x y plane that lies within the cylinder $S_2: x^2 + y^2 = a^2$. In Ax varies from $-a$ to a and for each x, y varies from $-\sqrt{a^2 - x^2}$ to $\sqrt{a^2 - x^2}$

$$\begin{aligned} s &= 2 \int_{x=-a}^a \int_{y=-\sqrt{a^2-x^2}}^{\sqrt{a^2-x^2}} \frac{a}{\sqrt{a^2-x^2}} dy dx \\ &= 2a \int_{-a}^a \frac{1}{\sqrt{a^2-x^2}} \left[y \right]_{-\sqrt{a^2-x^2}}^{\sqrt{a^2-x^2}} dx \\ &= 2a \int_{-a}^a \frac{1}{\sqrt{a^2-x^2}} \left[\sqrt{a^2-x^2} - (-\sqrt{a^2-x^2}) \right] dx \\ &= 4a \int_{-a}^a dx = 4a \left[x \right]_{-a}^a = 4a \left[a - (-a) \right] = 8a^2 \end{aligned}$$

Volume underneath a surface:

Let $Z=f(x,y)$ be the equation of the surface S. let P be a point on the surface S. let A denote the orthogonal projection of S on the xy- plane . divide it into area elements by drawing three lines parallel to the axes of x and y on the elements $\partial x \partial y$ as base , erect a cylinder having generators parallel to QZ and meeting the surface S in an element of area ∂s .the volume underneath the surface bounded by S, its projection A on xy plane and the cylinder with generator through the boundary curve of A on the xy plane and parallel to OZ is given by,

$$v = \iint_A f(x, y) dx dy = \iint_A Z dx dy$$

1) Find the volume of the ellipsoid $\frac{x^2}{a^2} + \frac{y^2}{b^2} + \frac{z^2}{c^2} = 1$

Sol: Let S denote the surface of the ellipsoid above the xy-plane .the equation of this surface

$$\frac{x^2}{a^2} + \frac{y^2}{b^2} + \frac{z^2}{c^2} = 1 \quad (z > 0)$$

is

$$\text{or, } z = c \left(1 - \frac{x^2}{a^2} - \frac{y^2}{b^2} \right)^{\frac{1}{2}} = f(x, y)$$

The volume of the region bounded by this surface and the xy -plane gives the volume v_1 of the upper half of the full ellipsoid. This volume is given by $v_1 = \iint_A c, y \, dxdy$

Where A is the area of the projection of S on the xy plane.

Note that A is the area bounded by the ellipse $\frac{x^2}{a^2} + \frac{y^2}{b^2} = 1$

$$\begin{aligned} \therefore v_1 &= \iint_A \left(1 - \frac{x^2}{a^2} - \frac{y^2}{b^2}\right)^{\frac{1}{2}} dxdy = c \left(\frac{2}{3} \pi ab\right) \\ &= \frac{2}{3} \pi ac \end{aligned}$$

The volume of the full ellipsoid is $2v_1$. Thus the required volume is $v = 2 \cdot \frac{2}{3} \pi abc = \frac{4}{3} \pi abc$

Volume of revolution using double integrals:

Let $y=f(x)$ be a simple closed plane curve enclosing an area A . Suppose this curve is revolved about the x -axis. Then it can be proved that the volume of the solid generated is given by the formula.

$$v = \iint_A 2\pi y dA = \iint 2\pi y dxdy$$

In polar form this formula becomes $v = \iint_A r^2 \sin \theta d\theta dr$

- 1) Find the volume generated by the revolution of the cardioids $r = a(1 + \cos \theta)$ about the initial line.

Sol: The given cardioid is symmetrical about the initial line $\theta = 0$. Therefore the volume generated by revolving the upper part of the curve about the initial line is same as the volume generated by revolving the whole curve. For the upper part of the curve θ varies from 0 to π and for each θ , r varies from 0 to $a(1 + \cos \theta)$, therefore the required volume is

$$\begin{aligned}
 v &= \int_{\theta=0}^{\pi} \int_{r=0}^{a(1+\cos\theta)} 2\pi r^2 \sin\theta dr d\theta \\
 &= 2\pi \int_0^{\pi} \sin\theta \left\{ \left[\frac{r^3}{3} \right]_0^{a(1+\cos\theta)} \right\} d\theta \\
 &= \frac{2\pi a^3}{3} \int_0^{\pi} (1+\cos\theta)^3 \sin\theta d\theta \\
 &= \frac{2\pi a^3}{3} \left[\frac{1+\cos\theta}{4} \right]_0^{\pi} = \frac{8}{3} \pi a^3
 \end{aligned}$$

Computation of volume by triple integrals:

Recall the expression,

$$\int_v f(x,y,z) dv = \iiint_R f(x,y,z) dx dy dz = \int_a^b \int_{g(x,y)}^{h(x,y)} \int_{\phi(x,y)}^{\psi(x,y)} f(x,y,z) dz dy dx$$

As a particular case, where $f(x,y,z)=1$, this expression becomes

$$\int_v dv = \iiint_R dx dy dz = \int_a^b \int_{g(x,y)}^{h(x,y)} \int_{\phi(x,y)}^{\psi(x,y)} dz dy dx \dots\dots\dots(1)$$

The integral $\int_v dv$ represents the volume V of the region R. thus expression (1) may be used to compute V.

If (x,y,z) are changed to (u,v,w) we obtained the following expression for the volume,

$$\int_v dv = \iiint_R dx dy dz = \iiint_{R^*} j du dv dw \dots\dots\dots(2)$$

Taking $(u,v,w) = (R,\phi,z)$ in (2)

We obtained $\int_v dv = \iiint_R R dR d\phi dz \dots\dots\dots(3)$ an expression for volume in terms of cylindrical polar coordinates.

Similarly $\int_v dv = \iiint_R r^2 \sin\theta dr d\theta d\phi$ an expression for volume in terms of spherical polar coordinates.

PROBLEMS:

1) Find the volume common to the cylinders $x^2+y^2=a^2$ and $x^2+z^2=a^2$

Soln: In the given region z varies from $-\sqrt{a^2-x^2}$ to $+\sqrt{a^2-x^2}$ and y varies from $-\sqrt{a^2-x^2}$ to $+\sqrt{a^2-x^2}$. for $z=0, y=0$ x varies from $-a$ to a

Therefore, required volume is

$$\begin{aligned}
 v &= \int_{x=-a}^a \int_{y=-\sqrt{a^2-x^2}}^{\sqrt{a^2-x^2}} \int_{z=-\sqrt{a^2-x^2}}^{\sqrt{a^2-x^2}} dz dy dx \\
 &= \int_{-a}^a \int_{-\sqrt{a^2-x^2}}^{\sqrt{a^2-x^2}} z \Big|_{-\sqrt{a^2-x^2}}^{\sqrt{a^2-x^2}} dy dx \\
 &= \int_{-a}^a \int_{-\sqrt{a^2-x^2}}^{\sqrt{a^2-x^2}} 2\sqrt{a^2-x^2} dy dx \\
 &= 2 \int_{-a}^a \left\{ \int_{-\sqrt{a^2-x^2}}^{\sqrt{a^2-x^2}} \sqrt{a^2-x^2} dy \right\} dx \\
 &= 2 \int_{-a}^a \left[\sqrt{a^2-x^2} y \right]_{-\sqrt{a^2-x^2}}^{\sqrt{a^2-x^2}} dx \\
 &= 2 \int_{-a}^a \sqrt{a^2-x^2} 2\sqrt{a^2-x^2} dx \\
 &= 4 \int_{-a}^a a^2-x^2 dx = 4 \left[a^2x - \frac{x^3}{3} \right]_{-a}^a \\
 &= 4 \left[\left(a^3 - \frac{a^3}{3} \right) - \left(-a^3 + \frac{a^3}{3} \right) \right] \\
 &= 4 \left[2a^3 - \frac{2a^3}{3} \right] = \frac{16a^3}{4}
 \end{aligned}$$

2) Find the volume bounded by the cylinder $x^2+y^2=4$ and the planes $y+z=3$ and $z=0$

Soln: Here z varies from 0 to $3-y$, y varies from $(-\sqrt{4-x^2})$ to $(\sqrt{4-x^2})$ and x varies from -2 to 2

∴ Required volume

$$\begin{aligned}
 V &= \int_{x=-2}^2 \int_{y=-\sqrt{4-x^2}}^{\sqrt{4-x^2}} \int_{z=0}^{3-y} dz dy dx \\
 &= \int_{-2}^2 dx \int_{-\sqrt{4-x^2}}^{\sqrt{4-x^2}} dy \int_0^{3-y} dz = \int_{-2}^2 dx \int_{-\sqrt{4-x^2}}^{\sqrt{4-x^2}} dy z \\
 &= \int_{-2}^2 dx \int_{-\sqrt{4-x^2}}^{\sqrt{4-x^2}} (3-y) dy = \int_{-2}^2 dx \left(3 - \frac{y^2}{2} \right) \Big|_{-\sqrt{4-x^2}}^{\sqrt{4-x^2}} \\
 &= \int_{-2}^2 \left[3\sqrt{4-x^2} - \frac{4-x^2}{2} + 3\sqrt{4-x^2} + \frac{4-x^2}{2} \right] dx \\
 &= 6 \int_{-2}^2 \sqrt{4-x^2} dx = 6 \left[\frac{x}{2} \sqrt{4-x^2} + \frac{4}{2} \sin^{-1} \frac{x}{2} \right]_{-2}^2 \\
 &= 6 \left[2 \sin^{-1} \frac{2}{2} - 2 \sin^{-1} \left(-\frac{2}{2} \right) \right] = 12 \left[\frac{\pi}{2} + \frac{\pi}{2} \right] = 12\pi
 \end{aligned}$$

BETA AND GAMMA FUNCTIONS

In this topic we define two special functions of improper integrals known as Beta function and Gamma function. These functions play important role in applied mathematics.

Definitions

1. The Beta function denoted by $B(m, n)$ or $\beta(m, n)$ is defined by

$$\beta(m, n) = \int_0^1 x^{m-1} (1-x)^{n-1} dx, (m, n > 0) \quad \dots(1)$$

2. The Gamma function denoted by $\Gamma(n)$ is defined by

$$\Gamma(n) = \int_0^{\infty} x^{n-1} \cdot e^{-x} dx \quad \dots(2)$$

Properties of Beta and Gamma Functions

$$1. \quad \beta(m, n) = \beta(n, m)$$

$$2. \quad \beta(m, n) = \int_0^{\infty} \frac{x^{m-1}}{(1+x)^{m+n}} dx = \int_0^{\infty} \frac{x^{n-1}}{(1+x)^{m+n}} dx \quad \dots(3)$$

$$3. \quad \beta(m, n) = 2 \int_0^{\pi/2} \sin^{2m-1} \theta \cos^{2n-1} \theta d\theta \quad \dots(4)$$

$$= 2 \int_0^{\pi/2} \sin^{2n-1} \theta \cos^{2m-1} \theta d\theta$$

$$4. \quad \beta\left[\frac{p+1}{2}, \frac{q+1}{2}\right] = 2 \int_0^{\pi/2} \sin^p \theta \cos^q \theta d\theta$$

$$= 2 \int_0^{\pi/2} \sin^q \theta \cos^p \theta d\theta \quad \dots(5)$$

$$5. \quad \Gamma(n+1) = n \Gamma(n) \quad \dots(6)$$

$$6. \quad \Gamma(n+1) = n!, \text{ if } n \text{ is a +ve real number.}$$

Proof 1. We have

$$\beta(m, n) = \int_0^1 x^{m-1} (1-x)^{n-1} dx$$

$$= \int_0^1 (1-x)^{m-1} [1-(1-x)]^{n-1} dx$$

$$\begin{aligned}
 \text{Since } \int_0^a f(x) dx &= \int_0^a f(a-x) dx \\
 &= \int_0^1 (1-x)^{m-1} (1-1+x)^{n-1} dx \\
 &= \int_0^1 x^{n-1} (1-x)^{m-1} dx \\
 &= \beta(n, m)
 \end{aligned}$$

$$\text{Thus, } \beta(m, n) = \beta(n, m)$$

Hence (1) is proved.

(2) By definition of Beta function,

$$\beta(m, n) = \int_0^1 x^{m-1} (1-x)^{n-1} dx$$

Substituting $x = \frac{1}{1+t}$ then $dx = \frac{-1}{(1+t)^2} dt$ when $x = 0, t = \infty$ and when $x = 1, t = 0$.

Therefore,

$$\beta(m, n) = \int_{\infty}^0 \left[\frac{1}{1+t} \right]^{m-1} \left[1 - \frac{1}{1+t} \right]^{n-1} \left\{ \frac{-1}{(1+t)^2} dt \right\}$$

$$\begin{aligned}
 &= \int_0^{\infty} \left(\frac{1}{1+t} \right)^{m-1} \left(\frac{t}{1+t} \right)^{n-1} \left\{ \frac{-1}{(1+t)^2} dt \right\} \\
 &= \int_0^{\infty} \frac{t^{n-1}}{(1+t)^{m-1+n-1+2}} dt \\
 \beta(m, n) &= \int_0^{\infty} \frac{t^{n-1}}{(1+t)^{m+n}} dt = \int_0^{\infty} \frac{x^{n-1}}{(1+x)^{m+n}} dx
 \end{aligned}$$

Similarly, $\beta(n, m) = \int_0^{\infty} \frac{x^{m-1}}{(1+x)^{m+n}} dx$

Since, $\beta(m, n) = \beta(n, m)$, we get

$$\beta(m, n) = \int_0^{\infty} \frac{x^{n-1}}{(1+x)^{m+n}} dx = \int_0^{\infty} \frac{x^{m-1}}{(1+x)^{m+n}} dx$$

(3) By definition of Beta functions

$$\beta(m, n) = \int_0^1 x^{m-1} (1-x)^{n-1} dx$$

Substitute $x = \sin^2 \theta$ then $dx = 2 \sin \theta \cos \theta d\theta$

Also when $x = 0, \theta = 0$

when $x = 1, \theta = \frac{\pi}{2}$

$$\begin{aligned}
 \therefore \beta(m, n) &= \int_0^{\pi/2} (\sin^2 \theta)^{m-1} \cdot (1 - \sin^2 \theta)^{n-1} \cdot 2 \sin \theta \cos \theta d\theta \\
 &= 2 \int_0^{\pi/2} \sin^{2m-2} \theta (\cos^2 \theta)^{n-1} \cdot \sin \theta \cos \theta d\theta \\
 &= 2 \int_0^{\pi/2} \sin^{2m-2} \theta \cos^{2n-2} \theta \sin \theta \cos \theta d\theta \\
 &= 2 \int_0^{\pi/2} \sin^{2m-1} \theta \cos^{2n-1} \theta d\theta
 \end{aligned}$$

Since, $\beta(m, n) = \beta(n, m)$, we have

$$\begin{aligned}\beta(m, n) &= 2 \int_0^{\pi/2} \sin^{2m-1} \theta \cos^{2n-1} \theta d\theta \\ &= 2 \int_0^{\pi/2} \sin^{2n-1} \theta \cos^{2m-1} \theta d\theta\end{aligned}$$

(4) Substituting $2m - 1 = p$ and $2n - 1 = q$

So that $m = \frac{p+1}{2}$, $n = \frac{q+1}{2}$ in the above result, we have

$$\begin{aligned}\beta\left(\frac{p+1}{2}, \frac{q+1}{2}\right) &= 2 \int_0^{\pi/2} \sin^p \theta \cos^q \theta d\theta \\ &= 2 \int_0^{\pi/2} \sin^q \theta \cos^p \theta d\theta\end{aligned}$$

(1) Substituting $q = 0$ in the above result, we get

$$\beta\left[\frac{p+1}{2}, \frac{1}{2}\right] = 2 \int_0^{\pi/2} \sin^p \theta d\theta = 2 \int_0^{\pi/2} \cos^p \theta d\theta.$$

(2) Substituting $p = 0$ and $q = 0$ in the above result

$$\beta\left(\frac{1}{2}, \frac{1}{2}\right) = 2 \int_0^{\pi/2} d\theta = \pi$$

(5) Replacing n by $(n + 1)$ in the definition of gamma function.

$$\Gamma(n) = \int_0^{\infty} x^{n-1} \cdot e^{-x} dx$$

where $n = (n + 1)$

$$\Gamma(n + 1) = \int_0^{\infty} x^n \cdot e^{-x} dx$$

On integrating by parts, we get

$$\begin{aligned}\Gamma(n + 1) &= \left[x^n \cdot (-e^{-x}) \right]_0^{\infty} - \int_0^{\infty} (-e^{-x}) \cdot n x^{n-1} dx \\ &= 0 + n \int_0^{\infty} e^{-x} x^{n-1} dx = n \Gamma(n).\end{aligned}$$

$$\left[\text{since } \lim_{x \rightarrow \infty} \frac{x^n}{e^x} = 0, \text{ if } n > 0 \right]$$

Thus, $\Gamma(n + 1) = n \Gamma(n),$ for $n > 0$

This is called the recurrence formula, for the gamma function.

(6) If n is a positive integer then by repeated application of the above formula, we get

$$\begin{aligned} \Gamma(n + 1) &= n \Gamma(n) \\ &= n \Gamma(n - 1 + 1) \\ &= n(n - 1) \Gamma(n - 1) \text{ (using above result)} \\ &= n(n - 1)(n - 2) \Gamma(n - 2) \\ &\dots\dots\dots \\ &\dots\dots\dots \\ &= n(n - 1)(n - 2)\dots\dots 1\Gamma(1) \\ &= n! \Gamma(1) \end{aligned}$$

But $\Gamma(1) = \int_0^{\infty} x^0 e^{-x} dx$
 $= -[e^{-x}]_0^{\infty} = -(0 - 1) = 1$

Hence $\Gamma(n + 1) = n!,$ if n is a positive integer.

For example

$$\Gamma(2) = 1! = 1, \Gamma(3) = 2! = 2, \Gamma(4) = 3! = 6$$

If n is a positive fraction then using the recurrence formula $\Gamma(n + 1) = n \Gamma(n)$ can be evaluated as follows.

$$\begin{aligned} (1) \Gamma\left(\frac{3}{2}\right) &= \Gamma\left(1 + \frac{1}{2}\right) = \frac{1}{2} \Gamma\left(\frac{1}{2}\right) \\ (2) \Gamma\left(\frac{5}{2}\right) &= \Gamma\left(\frac{3}{2} + 1\right) = \frac{3}{2} \Gamma\left(\frac{3}{2}\right) \\ (3) \Gamma\left(\frac{7}{2}\right) &= \Gamma\left(\frac{5}{2} + 1\right) = \frac{5}{2} \Gamma\left(\frac{5}{2}\right) \\ &= \frac{5}{2} \cdot \frac{3}{2} \cdot \frac{1}{2} \cdot \Gamma\left(\frac{1}{2}\right) \\ &= \frac{15}{8} \Gamma\left(\frac{1}{2}\right). \end{aligned}$$

Relationship between Beta and Gamma Functions

The Beta and Gamma functions are related by

$$\beta(m, n) = \frac{\Gamma(m)\Gamma(n)}{\Gamma(m+n)} \quad \dots(7)$$

Proof. We have $\Gamma(n) = \int_0^{\infty} x^{n-1} \cdot e^{-x} dx$

Substituting $x = t^2$, $dx = 2t dt$, we get

$$\Gamma(n) = \int_0^{\infty} (t^2)^{n-1} e^{-t^2} \cdot 2t dt$$

$$= 2 \int_0^{\infty} t^{2n-1} \cdot e^{-t^2} dt$$

$$\Gamma(n) = 2 \int_0^{\infty} x^{2n-1} e^{-x^2} dx \quad \dots(i)$$

Replacing n by m , and 'x' by 'y', we have

$$\Gamma(m) = 2 \int_0^{\infty} y^{2m-1} e^{-y^2} dy \quad \dots(ii)$$

Hence

$$\begin{aligned} \Gamma(m) \cdot \Gamma(n) &= \left\{ 2 \int_0^{\infty} x^{2n-1} e^{-x^2} dx \right\} \left\{ 2 \int_0^{\infty} y^{2m-1} e^{-y^2} dy \right\} \\ &= 4 \int_0^{\infty} \int_0^{\infty} x^{2n-1} e^{-x^2} y^{2m-1} \cdot e^{-y^2} dx dy \end{aligned}$$

$$= 4 \int_0^{\infty} \int_0^{\infty} e^{-(x^2+y^2)} x^{2n-1} y^{2m-1} dx dy \quad \dots(iii)$$

We shall transform the double integral into polar coordinates.

Substitute $x = r \cos \theta$, $y = r \sin \theta$ then we have $dx dy = r dr d\theta$

As x and y varies from 0 to ∞ , the region of integration entire first quadrant. Hence, θ varies

from 0 to $\frac{\pi}{2}$ and r varies from 0 to ∞ and also $x^2 + y^2 = r^2$

Hence (iii) becomes,

$$\begin{aligned} \Gamma(m) \Gamma(n) &= 4 \int_{r=0}^{\infty} \int_{\theta=0}^{\pi/2} e^{-r^2} (r \cos \theta)^{2n-1} (r \sin \theta)^{2m-1} \cdot r d\theta dr \\ &= 4 \int_{r=0}^{\infty} r^{2(m+n)-1} e^{-r^2} dr \times \int_0^{\frac{\pi}{2}} \sin^{2n-1} \theta \cos^{2m-1} \theta d\theta \quad \dots(iv) \end{aligned}$$

Substituting $r^2 = t$, in the first integral. We get,

$$\begin{aligned} \int_{r=0}^{\infty} r^{2(m+n)-1} e^{-r^2} dr &= \frac{1}{2} \int_0^{\infty} t^{m+n-1} e^{-t} dt \\ &= \frac{1}{2} \Gamma(m+n) \end{aligned}$$

and from (iv), $\int_0^{\frac{\pi}{2}} \sin^{2m-1} \theta \cos^{2n-1} \theta d\theta = \frac{1}{2} \beta(m, n)$

Therefore (iv) reduces to $\Gamma(m) \Gamma(n) = \Gamma(m+n) \beta(m, n)$

Thus, $\beta(m, n) = \frac{\Gamma(m) \Gamma(n)}{\Gamma(m+n)}$. Hence proved.

Corollary. To show that $\Gamma\left(\frac{1}{2}\right) = \sqrt{\pi}$

Putting $m = n = \frac{1}{2}$ in this result, we get

$$\beta\left[\frac{1}{2}, \frac{1}{2}\right] = \frac{\Gamma\left[\frac{1}{2}\right] \cdot \Gamma\left[\frac{1}{2}\right]}{\Gamma[1]}$$

But $\Gamma(1) = 1$

$$\therefore \beta\left[\frac{1}{2}, \frac{1}{2}\right] = \left\{\Gamma\left(\frac{1}{2}\right)\right\}^2 \quad \dots(8)$$

Now consider $\beta(m, n) = 2 \int_0^{\frac{\pi}{2}} \sin^{2m-1} \theta \cos^{2n-1} \theta d\theta$

Now we have from (8), L.H.S.

$$\begin{aligned} \beta\left[\frac{1}{2}, \frac{1}{2}\right] &= 2 \int_0^{\frac{\pi}{2}} \sin^0 \theta \cos^0 \theta d\theta = 2 [\theta]_0^{\frac{\pi}{2}} = \pi \\ \pi &= \Gamma\left\{\frac{1}{2}\right\}^2 \quad \therefore \Gamma\left[\frac{1}{2}\right] = \sqrt{\pi}. \end{aligned}$$

Prove that $\int_0^{\infty} a^{-bx^2} dx = \frac{\sqrt{\pi}}{2\sqrt{b \log a}}$ where a and b are positive constants.

1.

Sol:

$$\begin{aligned} \text{Now, } \int_0^{\infty} a^{-bx^2} dx &= \int_0^{\infty} \{e^{\log a}\}^{-bx^2} dx \quad \text{since } a = e^{\log a} \\ &= \int_0^{\infty} e^{-(b \log a)x^2} dx \end{aligned}$$

$$\text{Substitute } (b \log a) x^2 = t, \quad dx = \frac{dt}{(b \log a) \cdot 2x}$$

$$\text{So that, } x = \frac{\sqrt{t}}{\sqrt{b \log a}}$$

$$\therefore dx = \frac{dt}{2\sqrt{t} \sqrt{b \log a}}$$

$$\int_0^{\infty} e^{-bx^2} dx = \int_0^{\infty} e^{-t} \cdot \frac{dt}{2\sqrt{t} \sqrt{b \log a}}$$

$$= \frac{1}{2\sqrt{b \log a}} \int_0^{\infty} t^{-\frac{1}{2}} e^{-t} dt$$

$$= \frac{1}{2\sqrt{b \log a}} \int_0^{\infty} t^{\frac{1}{2}-1} e^{-t} dt$$

$$= \frac{1}{2\sqrt{b \log a}} \Gamma\left(\frac{1}{2}\right)$$

$$= \frac{\sqrt{\pi}}{2\sqrt{b \log a}}$$

Prove that $\int_0^{\infty} x^m e^{-ax^n} dx = \frac{1}{na^{\frac{(m+1)}{n}}} \Gamma\left(\frac{m+1}{n}\right)$, where m and n are positive constants.

2.

Substitute $ax^n = t$ so that $x = \left(\frac{t}{a}\right)^{\frac{1}{n}}$

Then $dx = \frac{1}{na^{\frac{1}{n}}} \cdot t^{\frac{1}{n}-1} dt$

Therefore,

$$\begin{aligned} \int_0^{\infty} x^m e^{-ax^n} dx &= \int_0^{\infty} \left[\left(\frac{t}{a}\right)^{\frac{1}{n}}\right]^m e^{-t} \cdot \frac{t^{\frac{1}{n}-1}}{na^{\frac{1}{n}}} dt \\ &= \frac{1}{na^{\frac{(m+1)}{n}}} \int_0^{\infty} t^{\frac{(m+1)}{n}-1} e^{-t} dt \\ &= \frac{1}{na^{\frac{(m+1)}{n}}} \Gamma\left[\frac{m+1}{n}\right]. \end{aligned}$$

MODULE – 5

LAPLACE TRANSFORM

INTRODUCTION

- Laplace transform is an integral transform employed in solving physical problems.
- Many physical problems when analysed assumes the form of a differential equation subjected to a set of initial conditions or boundary conditions.
- By initial conditions we mean that the conditions on the dependent variable are specified at a single value of the independent variable.
- If the conditions of the dependent variable are specified at two different values of the independent variable, the conditions are called boundary conditions.
- The problem with initial conditions is referred to as the Initial value problem.
- The problem with boundary conditions is referred to as the Boundary value problem.

Example 1: The problem of solving the equation $\frac{d^2 y}{dx^2} + \frac{dy}{dx} + y = x$ with conditions $y(0) = y'(0) = 1$ is an initial value problem.

Example 2: The problem of solving the equation $3\frac{d^2 y}{dx^2} + 2\frac{dy}{dx} + y = \cos x$ with $y(1)=1, y(2)=3$ is called Boundary value problem.

Laplace transform is essentially employed to solve initial value problems. This technique is of great utility in applications dealing with mechanical systems and electric circuits. Besides the technique may also be employed to find certain integral values also. The transform is named after the French Mathematician P.S. de' Laplace (1749 – 1827).

The subject is divided into the following sub topics.

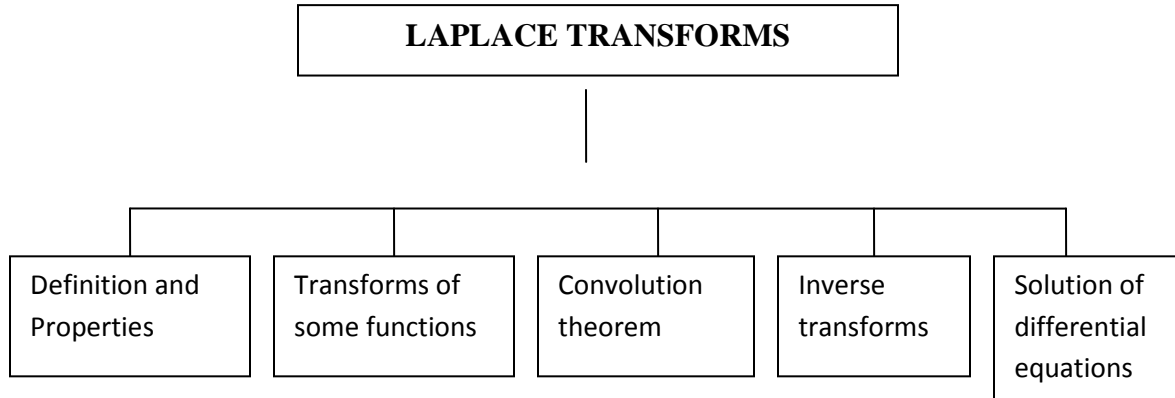
**Definition:**

Let $f(t)$ be a real-valued function defined for all $t \geq 0$ and s be a parameter, real or complex. Suppose the integral $\int_0^{\infty} e^{-st} f(t) dt$ exists (converges). Then this integral is called the Laplace transform of $f(t)$ and is denoted by $L[f(t)]$.

$$\text{Thus, } L[f(t)] = \int_0^{\infty} e^{-st} f(t) dt \quad (1)$$

We note that the value of the integral on the right hand side of (1) depends on s . Hence $L[f(t)]$ is a function of s denoted by $F(s)$ or $\bar{f}(s)$.

$$\text{Thus, } L[f(t)] = F(s) \quad (2)$$

Consider relation (2). Here $f(t)$ is called the Inverse Laplace transform of $F(s)$ and is denoted by $L^{-1} [F(s)]$.

$$\text{Thus, } L^{-1} [F(s)] = f(t) \quad (3)$$

Suppose $f(t)$ is defined as follows :

$$f(t) = \begin{cases} f_1(t), & 0 < t < a \\ f_2(t), & a < t < b \\ f_3(t), & t > b \end{cases}$$

Note that $f(t)$ is piecewise continuous. The Laplace transform of $f(t)$ is defined as

$$L[f(t)] = \int_0^{\infty} e^{-st} f(t) dt$$

$$= \int_0^a e^{-st} f_1(t) dt + \int_a^b e^{-st} f_2(t) dt + \int_b^{\infty} e^{-st} f_3(t) dt$$

NOTE: In a practical situation, the variable t represents the time and s represents frequency.

Hence the Laplace transform converts the time domain into the frequency domain.

Basic properties

The following are some basic properties of Laplace transforms:

1. **Linearity property**: For any two functions $f(t)$ and $\phi(t)$ (whose Laplace transforms exist)

and any two constants a and b , we have

$$L [a f(t) + b \phi(t)] = a L[f(t)] + b L[\phi(t)]$$

Proof :- By definition, we have

$$L [af(t) + b\phi(t)] = \int_0^{\infty} e^{-st} [af(t) + b\phi(t)] dt = a \int_0^{\infty} e^{-st} f(t) dt + b \int_0^{\infty} e^{-st} \phi(t) dt$$

$$= a L[f(t)] + b L[\phi(t)]$$

This is the desired property.

In particular, for $a=b=1$, we have

$$L [f(t) + \phi(t)] = L [f(t)] + L[\phi(t)]$$

and for $a = -b = 1$, we have $L [f(t) - \phi(t)] = L [f(t)] - L[\phi(t)]$

2. **Change of scale property**: If $L[f(t)] = F(s)$, then $L[f(at)] = \frac{1}{a} F\left(\frac{s}{a}\right)$, where a is a

positive constant.

Proof: - By definition, we have

$$L[f(at)] = \int_0^{\infty} e^{-st} f(at) dt \quad (1)$$

Let us set $at = x$. Then expression (1) becomes,

$$\begin{aligned} L f(at) &= \frac{1}{a} \int_0^{\infty} e^{-\left(\frac{s}{a}\right)x} f(x) dx \\ &= \frac{1}{a} F\left(\frac{s}{a}\right) \end{aligned}$$

This is the desired property.

3. **Shifting property:** -Let a be any real constant. Then

$$L [e^{at} f(t)] = F(s-a)$$

Proof :- By definition, we have

$$\begin{aligned} L [e^{at} f(t)] &= \int_0^{\infty} e^{-st} e^{at} f(t) dt \\ &= \int_0^{\infty} e^{-(s-a)t} f(t) dt \\ &= F(s-a) \end{aligned}$$

This is the desired property. Here we note that the Laplace transform of $e^{at} f(t)$ can be written down directly by changing s to $s-a$ in the Laplace transform of $f(t)$.

LAPLACE TRANSFORMS OF STANDARD FUNCTIONS

1. Let a be a constant. Then

$$\begin{aligned} L[e^{at}] &= \int_0^{\infty} e^{-st} e^{at} dt = \int_0^{\infty} e^{-(s-a)t} dt \\ &= \frac{e^{-(s-a)t}}{-(s-a)} \Big|_0^{\infty} = \frac{1}{s-a}, \quad s > a \end{aligned}$$

Thus,

$$L[(e^{at})] = \frac{1}{s-a}$$

In particular, when $a=0$, we get

$$L(1) = \frac{1}{s}, \quad s > 0$$

By inversion formula, we have

$$L^{-1} \frac{1}{s-a} = e^{at} L^{-1} \frac{1}{s} = e^{at}$$

$$\begin{aligned} 2. \quad L(\cosh at) &= L\left(\frac{e^{at} + e^{-at}}{2}\right) = \frac{1}{2} \int_0^{\infty} e^{-st} \left[e^{at} + e^{-at} \right] dt \\ &= \frac{1}{2} \int_0^{\infty} \left[e^{-(s-a)t} + e^{-(s+a)t} \right] dt \end{aligned}$$

Let $s > |a|$. Then,

$$L(\cosh at) = \frac{1}{2} \left[\frac{e^{-(s-a)t}}{-(s-a)} + \frac{e^{-(s+a)t}}{-(s+a)} \right]_0^{\infty} = \frac{s}{s^2 - a^2}$$

$$\text{Thus, } L(\cosh at) = \frac{s}{s^2 - a^2}, \quad s > |a|$$

and so

$$L^{-1}\left(\frac{s}{s^2 - a^2}\right) = \cosh at$$

$$3. \quad L(\sinh at) = L\left(\frac{e^{at} - e^{-at}}{2}\right) = \frac{a}{s^2 - a^2}, \quad s > |a|$$

Thus,

$$L(\sinh at) = \frac{a}{s^2 - a^2}, \quad s > |a|$$

and so,

$$L^{-1}\left(\frac{1}{s^2 - a^2}\right) = \frac{\sinh at}{a}$$

$$4. L(\sin at) = \int_0^{\infty} e^{-st} \sin at \, dt$$

Here we suppose that $s > 0$ and then integrate by using the formula

$$\int e^{ax} \sin bxdx = \frac{e^{ax}}{a^2 + b^2} [\sin bx - b \cos bx]$$

Thus,

$$L(\sinh at) = \frac{a}{s^2 + a^2}, \quad s > 0$$

and so

$$L^{-1}\left(\frac{1}{s^2 + a^2}\right) = \frac{\sinh at}{a}$$

$$5. L(\cos at) = \int_0^{\infty} e^{-st} \cos at \, dt$$

Here we suppose that $s > 0$ and integrate by using the formula

$$\int e^{ax} \cos bxdx = \frac{e^{ax}}{a^2 + b^2} [\cos bx + b \sin bx]$$

$$\text{Thus, } L(\cos at) = \frac{s}{s^2 + a^2}, \quad s > 0$$

and so
$$L^{-1} \frac{s}{s^2 + a^2} = \cos at$$

6. Let n be a constant, which is a non-negative real number or a negative non-integer. Then

$$L(t^n) = \int_0^{\infty} e^{-st} t^n dt$$

Let $s > 0$ and set $st = x$, then

$$L(t^n) = \int_0^{\infty} e^{-x} \left(\frac{x}{s}\right)^n \frac{dx}{s} = \frac{1}{s^{n+1}} \int_0^{\infty} e^{-x} x^n dx$$

The integral $\int_0^{\infty} e^{-x} x^n dx$ is called gamma function of $(n+1)$ denoted by $\Gamma(n+1)$. Thus

$$L(t^n) = \frac{\Gamma(n+1)}{s^{n+1}}$$

In particular, if n is a non-negative integer then $\Gamma(n+1) = n!$. Hence

$$L(t^n) = \frac{n!}{s^{n+1}}$$

and so

$$L^{-1} \frac{1}{s^{n+1}} = \frac{t^n}{\Gamma(n+1)} \text{ or } \frac{t^n}{n!} \text{ as the case may be}$$

Application of shifting property:-

The shifting property is

If $L f(t) = F(s)$, then $L [e^{at}f(t)] = F(s-a)$

Application of this property leads to the following results :

$$1. L(e^{at} \cosh bt) = \mathbf{L}(\cosh bt) \Big|_{s \rightarrow s-a} = \left(\frac{s}{s^2 - b^2} \right) \Big|_{s \rightarrow s-a} = \frac{s-a}{(s-a)^2 - b^2}$$

Thus,

$$L(e^{at} \cosh bt) = \frac{s-a}{(s-a)^2 - b^2}$$

and

$$L^{-1} \frac{s-a}{(s-a)^2 - b^2} = e^{at} \cosh bt$$

$$2. L(e^{at} \sinh bt) = \frac{a}{(s-a)^2 - b^2}$$

and

$$L^{-1} \frac{1}{(s-a)^2 - b^2} = e^{at} \sinh bt$$

$$3. L(e^{at} \cos bt) = \frac{s-a}{(s-a)^2 + b^2}$$

and

$$L^{-1} \frac{s-a}{(s-a)^2 + b^2} = e^{at} \cos bt$$

$$4. L(e^{at} \sin bt) = \frac{b}{(s-a)^2 - b^2}$$

and

$$L^{-1} \frac{1}{(s-a)^2 - b^2} = \frac{e^{at} \sin bt}{b}$$

$$5. L(e^{at} t^n) = \frac{\Gamma(n+1)}{(s-a)^{n+1}} \quad \text{or} \quad \frac{n!}{(s-a)^{n+1}} \quad \text{as the case may be}$$

Hence

$$L^{-1} \frac{1}{(s-a)^{n+1}} = \frac{e^{at} t^n}{\Gamma(n+1)} \quad \text{or} \quad \frac{n!}{(s-a)^{n+1}} \quad \text{as the case may be}$$

Examples :-

$$1. \text{ Find } L[f(t)] \text{ given } f(t) = \begin{cases} t, & 0 < t < 3 \\ 4, & t > 3 \end{cases}$$

Here

$$L[f(t)] = \int_0^{\infty} e^{-st} f(t) dt = \int_0^3 e^{-st} t dt + \int_3^{\infty} 4e^{-st} dt$$

Integrating the terms on the RHS, we get

$$L[f(t)] = \frac{1}{s} e^{-3s} + \frac{1}{s^2} (1 - e^{-3s})$$

This is the desired result.

$$2. \text{ Find } L[f(t)] \text{ given } L[f(t)] = \begin{cases} \sin 2t, & 0 < t \leq \pi \\ 0, & t > \pi \end{cases}$$

Here

$$L[f(t)] = \int_0^{\pi} e^{-st} f(t) dt + \int_{\pi}^{\infty} e^{-st} f(t) dt = \int_0^{\pi} e^{-st} \sin 2t dt$$

$$= \left[\frac{e^{-st}}{s^2 + 4} \left(s \sin 2t - 2 \cos 2t \right) \right]_0^{\infty} = \frac{2}{s^2 + 4} \left[-e^{-\pi s} \right]$$

This is the desired result.

3. Evaluate: (i) $L(\sin 3t \sin 4t)$
(ii) $L(\cos^2 4t)$
(iii) $L(\sin^3 2t)$

(i) Here $L(\sin 3t \sin 4t) = L \left[\frac{1}{2} (\cos t - \cos 7t) \right]$

$$= \frac{1}{2} \left[L(\cos t) - L(\cos 7t) \right], \text{ by using linearity property}$$

$$= \frac{1}{2} \left[\frac{s}{s^2 + 1} - \frac{s}{s^2 + 49} \right] = \frac{24s}{(s^2 + 1)(s^2 + 49)}$$

(ii) Here

$$L(\cos^2 4t) = L \left[\frac{1}{2} (1 + \cos 8t) \right] = \frac{1}{2} \left[\frac{1}{s} + \frac{s}{s^2 + 64} \right]$$

(iii) We have

$$\sin^3 \theta = \frac{1}{4} (\sin \theta - \sin 3\theta)$$

For $\theta=2t$, we get

$$\sin^3 2t = \frac{1}{4} (\sin 2t - \sin 6t)$$

so that

$$L(\sin^3 2t) = \frac{1}{4} \left[\frac{6}{s^2 + 4} - \frac{6}{s^2 + 36} \right] = \frac{48}{(s^2 + 4)(s^2 + 36)}$$

This is the desired result.

4. Find $L(\cos t \cos 2t \cos 3t)$

$$\text{Here } \cos 2t \cos 3t = \frac{1}{2}[\cos 5t + \cos t]$$

so that

$$\begin{aligned} \cos t \cos 2t \cos 3t &= \frac{1}{2}[\cos 5t \cos t + \cos^2 t] \\ &= \frac{1}{4}[\cos 6t + \cos 4t + 1 + \cos 2t] \end{aligned}$$

$$\text{Thus } L(\cos t \cos 2t \cos 3t) = \frac{1}{4} \left[\frac{s}{s^2 + 36} + \frac{s}{s^2 + 16} + \frac{1}{s} + \frac{s}{s^2 + 4} \right]$$

5. Find $L(\cosh^2 2t)$

We have

$$\cosh^2 \theta = \frac{1 + \cosh 2\theta}{2}$$

For $\theta = 2t$, we get

$$\cosh^2 2t = \frac{1 + \cosh 4t}{2}$$

Thus,

$$L(\cosh^2 2t) = \frac{1}{2} \left[\frac{1}{s} + \frac{s}{s^2 - 16} \right]$$

6. Evaluate (i) $L(\sqrt{t})$ (ii) $L\left(\frac{1}{\sqrt{t}}\right)$ (iii) $L(t^{-3/2})$

$$\text{We have } L(t^n) = \frac{\Gamma(n+1)}{s^{n+1}}$$

(i) For $n = \frac{1}{2}$, we get

$$L(t^{1/2}) = \frac{\Gamma\left(\frac{1}{2} + 1\right)}{s^{3/2}}$$

Since $\Gamma(n+1) = n\Gamma(n)$, we have $\Gamma\left(\frac{1}{2} + 1\right) = \frac{1}{2}\Gamma\left(\frac{1}{2}\right) = \frac{\sqrt{\pi}}{2}$

$$\text{Thus, } L(\sqrt{t}) = \frac{\sqrt{\pi}}{2s^{3/2}}$$

(ii) For $n = -\frac{1}{2}$, we get

$$L(t^{-1/2}) = \frac{\Gamma\left(\frac{1}{2}\right)}{s^{1/2}} = \frac{\sqrt{\pi}}{\sqrt{s}}$$

(iii) For $n = -\frac{3}{2}$, we get

$$L(t^{-3/2}) = \frac{\Gamma\left(-\frac{1}{2}\right)}{s^{-1/2}} = \frac{-2\sqrt{\pi}}{s^{-1/2}} = -2\sqrt{\pi s}$$

7. Evaluate: (i) $L(t^2)$ (ii) $L(t^3)$

We have,

$$L(t^n) = \frac{n!}{s^{n+1}}$$

(i) For $n = 2$, we get

$$L(t^2) = \frac{2!}{s^3} = \frac{2}{s^3}$$

(ii) For $n=3$, we get

$$L(t^3) = \frac{3!}{s^4} = \frac{6}{s^4}$$

8. Find $L[e^{-3t}(2\cos 5t - 3\sin 5t)]$

Given =

$$\begin{aligned}
 & 2L(e^{-3t} \cos 5t) - 3L(e^{-3t} \sin 5t) \\
 &= 2 \frac{e^{-3t}}{(s+3)^2 + 25} - \frac{15}{(s+3)^2 + 25}, \text{ by using shifting property} \\
 &= \frac{2s-9}{s^2 + 6s + 34}, \text{ on simplification}
 \end{aligned}$$

9. Find L [coshat sinhat]

$$\begin{aligned}
 \text{Here } L[\coshat \sinat] &= L\left[\frac{e^{at} + e^{-at}}{2} \sin at\right] \\
 &= \frac{1}{2} \left[\frac{a}{(s-a)^2 + a^2} + \frac{a}{(s+a)^2 + a^2} \right] \\
 &= \frac{a(s^2 + 2a^2)}{[(s-a)^2 + a^2][(s+a)^2 + a^2]}, \text{ on simplification}
 \end{aligned}$$

10. Find L (cosht sin³ 2t)

Given

$$\begin{aligned}
 & L\left[\left(\frac{e^t + e^{-t}}{2}\right) \left(\frac{3 \sin 2t - \sin 6t}{4}\right)\right] \\
 &= \frac{1}{8} \left[L(e^t \sin 2t) - L(e^t \sin 6t) + 3L(e^{-t} \sin 2t) - L(e^{-t} \sin 6t) \right] \\
 &= \frac{1}{8} \left[\frac{6}{(s-1)^2 + 4} - \frac{6}{(s-1)^2 + 36} + \frac{6}{(s+1)^2 + 4} - \frac{6}{(s+1)^2 + 36} \right] \\
 &= \frac{3}{4} \left[\frac{1}{(s-1)^2 + 4} - \frac{1}{(s-1)^2 + 36} + \frac{1}{(s+1)^2 + 4} - \frac{1}{(s+1)^2 + 36} \right]
 \end{aligned}$$

11. Find $L(e^{-4t}t^{-5/2})$

We have

$$L(t^n) = \frac{\Gamma(n+1)}{s^{n+1}} \quad \text{Put } n = -5/2. \text{ Hence}$$

$$L(t^{-5/2}) = \frac{\Gamma(-3/2)}{s^{-3/2}} = \frac{4\sqrt{\pi}}{3s^{-3/2}} \quad \text{Change } s \text{ to } s+4.$$

$$\text{Therefore, } L(e^{-4t}t^{-5/2}) = \frac{4\sqrt{\pi}}{3(s+4)^{-3/2}}$$

Transform of $t^n f(t)$

Here we suppose that n is a positive integer. By definition, we have

$$F(s) = \int_0^{\infty} e^{-st} f(t) dt$$

Differentiating 'n' times on both sides w.r.t. s, we get

$$\frac{d^n}{ds^n} F(s) = \frac{\partial^n}{\partial s^n} \int_0^{\infty} e^{-st} f(t) dt$$

Performing differentiation under the integral sign, we get

$$\frac{d^n}{ds^n} F(s) = \int_0^{\infty} (-t)^n e^{-st} f(t) dt$$

Multiplying on both sides by $(-1)^n$, we get

$$(-1)^n \frac{d^n}{ds^n} F(s) = \int_0^{\infty} (t^n f(t) e^{-st} dt = L[t^n f(t)], \text{ by definition}$$

Thus,

$$L[t^n f(t)] = (-1)^n \frac{d^n}{ds^n} F(s)$$

This is the transform of $t^n f(t)$.

Also,

$$L^{-1}\left[\frac{d^n}{ds^n} F(s)\right] = (-1)^n t^n f(t)$$

In particular, we have

$$L[t f(t)] = -\frac{d}{ds} F(s), \text{ for } n=1$$

$$L[t^2 f(t)] = \frac{d^2}{ds^2} F(s), \text{ for } n=2, \text{ etc.}$$

Also, $L^{-1}\left[\frac{d}{ds} F(s)\right] = -tf(t)$ and

$$L^{-1}\left[\frac{d^2}{ds^2} F(s)\right] = t^2 f(t)$$

Transform of $\frac{f(t)}{t}$

We have, $F(s) = \int_0^{\infty} e^{-st} f(t) dt$

Therefore,

$$\begin{aligned} \int_s^{\infty} F(s) ds &= \int_s^{\infty} \left[\int_0^{\infty} e^{-st} f(t) dt \right] ds \\ &= \int_0^{\infty} f(t) \left[\int_s^{\infty} e^{-st} ds \right] dt \\ &= \int_0^{\infty} f(t) \left[\frac{e^{-st}}{-t} \right]_s^{\infty} dt \end{aligned}$$

$$= \int_0^{\infty} e^{-st} \left[\frac{f(t)}{t} \right] dt = L\left(\frac{f(t)}{t} \right)$$

Thus,
$$L\left(\frac{f(t)}{t} \right) = \int_s^{\infty} F(s) ds$$

This is the transform of $\frac{f(t)}{t}$

Also,
$$L^{-1} \int_s^{\infty} F(s) ds = \frac{f(t)}{t}$$

Examples :

1. Find L [$t e^{-t} \sin 4t$]

We have,
$$L[e^{-t} \sin 4t] = \frac{4}{(s+1)^2 + 16}$$

So that,

$$\begin{aligned} L[t e^{-t} \sin 4t] &= 4 \left[-\frac{d}{ds} \left\{ \frac{1}{s^2 + 2s + 17} \right\} \right] \\ &= \frac{8(s+1)}{(s^2 + 2s + 17)^2} \end{aligned}$$

2. Find L ($t^2 \sin 3t$)

We have
$$L(\sin 3t) = \frac{3}{s^2 + 9}$$

So that,

$$\begin{aligned} L(t^2 \sin 3t) &= \frac{d^2}{ds^2} \left(\frac{3}{s^2 + 9} \right) \\ &= -6 \frac{d}{ds} \frac{s}{(s^2 + 9)^2} \\ &= \frac{18(s^2 - 3)}{(s^2 + 9)^3} \end{aligned}$$

3. Find $L\left(\frac{e^{-t} \sin t}{t}\right)$

We have

$$L(e^{-t} \sin t) = \frac{1}{(s+1)^2 + 1}$$

$$\text{Hence } L\left(\frac{e^{-t} \sin t}{t}\right) = \int_0^{\infty} \frac{ds}{(s+1)^2 + 1} = \left[\tan^{-1}(s+1) \right]_0^{\infty}$$

$$= \frac{\pi}{2} - \tan^{-1}(s+1) = \cot^{-1}(s+1)$$

4. Find $L\left(\frac{\sin t}{t}\right)$. Using this, evaluate $L\left(\frac{\sin at}{t}\right)$

$$\text{We have } L(\sin t) = \frac{1}{s^2 + 1}$$

$$\text{So that } L\left[\frac{\sin t}{t}\right] = \int_s^{\infty} \frac{ds}{s^2 + 1} = \left[\tan^{-1} s \right]_s^{\infty}$$

$$= \frac{\pi}{2} - \tan^{-1} s = \cot^{-1} s = F(s)$$

Consider

$$L\left(\frac{\sin at}{t}\right) = a L\left(\frac{\sin at}{at}\right) = a Lf(at)$$

$$= a \left[\frac{1}{a} F\left(\frac{s}{a}\right) \right], \text{ in view of the change of scale property}$$

$$= \cot^{-1}\left(\frac{s}{a}\right)$$

5. Find $L\left[\frac{\cos at - \cos bt}{t}\right]$

We have $L[\cos at - \cos bt] = \frac{s}{s^2 + a^2} - \frac{s}{s^2 + b^2}$

So that $L\left[\frac{\cos at - \cos bt}{t}\right] = \int_s^\infty \left[\frac{s}{s^2 + a^2} - \frac{s}{s^2 + b^2}\right] ds$

$$= \frac{1}{2} \left[\log \left(\frac{s^2 + a^2}{s^2 + b^2} \right) \right]_s^\infty$$

$$= \frac{1}{2} \left[\lim_{s \rightarrow \infty} L t \log \left(\frac{s^2 + a^2}{s^2 + b^2} \right) - \log \left(\frac{s^2 + a^2}{s^2 + b^2} \right) \right]$$

$$= \frac{1}{2} \left[0 + \log \left(\frac{s^2 + b^2}{s^2 + a^2} \right) \right]$$

$$= \frac{1}{2} \log \left(\frac{s^2 + b^2}{s^2 + a^2} \right)$$

6. Prove that $\int_0^\infty e^{-3t} t \sin t dt = \frac{3}{50}$

We have

$$\begin{aligned} \int_0^\infty e^{-st} t \sin t dt &= L(t \sin t) = -\frac{d}{ds} L(\sin t) = -\frac{d}{ds} \left[\frac{1}{s^2 + 1} \right] \\ &= \frac{2s}{(s^2 + 1)^2} \end{aligned}$$

Putting $s = 3$ in this result, we get

$$\int_0^\infty e^{-3t} t \sin t dt = \frac{3}{50}$$

This is the result as required.

Consider

$$\begin{aligned}
 L f'(t) &= \int_0^{\infty} e^{-st} f'(t) dt \\
 &= \left[e^{-st} f(t) \right]_0^{\infty} - \int_0^{\infty} (-s) e^{-st} f(t) dt, \text{ by using integration by parts} \\
 &= \left[e^{-st} f(t) - f(0) \right]_0^{\infty} + s L f(t) \\
 &= 0 - f(0) + s L[f(t)]
 \end{aligned}$$

Thus

$$L f'(t) = s L[f(t)] - f(0)$$

Similarly,

$$L f''(t) = s^2 L[f(t)] - s f(0) - f'(0)$$

In general, we have

$$L f^n(t) = s^n L f(t) - s^{n-1} f(0) - s^{n-2} f'(0) - \dots - f^{n-1}(0)$$

Transform of $\int_0^t f(t) dt$

Let $\phi(t) = \int_0^t f(t) dt$. Then $\phi(0) = 0$ and $\phi'(t) = f(t)$

$$\begin{aligned}
 \text{Now, } L \phi(t) &= \int_0^{\infty} e^{-st} \phi(t) dt \\
 &= \left[\phi(t) \frac{e^{-st}}{-s} \right]_0^{\infty} - \int_0^{\infty} \phi'(t) \frac{e^{-st}}{-s} dt
 \end{aligned}$$

$$= (0-0) + \frac{1}{s} \int_0^{\infty} f(t)e^{-st} dt$$

Thus, $L \int_0^t f(t) dt = \frac{1}{s} L[f(t)]$

Also, $L^{-1} \left[\frac{1}{s} L[f(t)] \right] = \int_0^t f(t) dt$

Examples:

1. By using the Laplace transform of $\sin at$, find the Laplace transforms of $\cos at$.

Let $f(t) = \sin at$, then $Lf(t) = \frac{a}{s^2 + a^2}$

We note that

$$f'(t) = a \cos at$$

Taking Laplace transforms, we get

$$Lf'(t) = L(a \cos at) = aL(\cos at)$$

or $L(\cos at) = \frac{1}{a} Lf'(t) = \frac{1}{a} [Lf(t) - f(0)]$

$$= \frac{1}{a} \left[\frac{sa}{s^2 + a^2} - 0 \right]$$

Thus

$$L(\cos at) = \frac{s}{s^2 + a^2}$$

This is the desired result.

2. Given $L \left[2\sqrt{\frac{t}{\pi}} \right] = \frac{1}{s^{3/2}}$, show that $L \left[\frac{1}{\sqrt{\pi t}} \right] = \frac{1}{\sqrt{s}}$

Let $f(t) = 2\sqrt{\frac{t}{\pi}}$, given $L[f(t)] = \frac{1}{s^{3/2}}$

We note that, $f'(t) = \frac{2}{\sqrt{\pi}} \frac{1}{2\sqrt{t}} = \frac{1}{\sqrt{\pi t}}$

Taking Laplace transforms, we get

$$L f'(t) = L \left[\frac{1}{\sqrt{\pi t}} \right]$$

Hence

$$\begin{aligned} L \left[\frac{1}{\sqrt{\pi t}} \right] &= L f'(t) = s L f(t) - f(0) \\ &= s \left(\frac{1}{s^{3/2}} \right) - 0 \end{aligned}$$

Thus
$$L \left[\frac{1}{\sqrt{\pi t}} \right] = \frac{1}{\sqrt{s}}$$

This is the result as required.

3. Find
$$L \int_0^t \left(\frac{\cos at - \cos bt}{t} \right) dt$$

Here
$$L[f(t)] = L \left(\frac{\cos at - \cos bt}{t} \right) = \frac{1}{2} \log \left(\frac{s^2 + b^2}{s^2 + a^2} \right)$$

Using the result
$$L \int_0^t f(t) dt = \frac{1}{s} L f(t)$$

We get,
$$L \int_0^t \left(\frac{\cos at - \cos bt}{t} \right) dt = \frac{1}{2s} \log \left(\frac{s^2 + b^2}{s^2 + a^2} \right)$$

4. Find
$$L \int_0^t e^{-t} \sin 4t dt$$

Here $L \left[e^{-t} \sin 4t \right] = \frac{8(s+1)}{(s^2 + 2s + 17)^2}$

Thus $L \int_0^t e^{-t} \sin 4t dt = \frac{8(s+1)}{s(s^2 + 2s + 17)^2}$

Laplace Transform of a periodic function

Formula: Let $f(t)$ be a periodic function of period T . Then

$$Lf(t) = \frac{1}{1 - e^{-sT}} \int_0^T e^{-st} f(t) dt$$

Proof :By definition, we have

$$\begin{aligned} Lf(t) &= \int_0^{\infty} e^{-st} f(t) dt = \int_0^{\infty} e^{-su} f(u) du \\ &= \int_0^T e^{-su} f(u) du + \int_T^{2T} e^{-su} f(u) du + \dots + \int_{nT}^{(n+1)T} e^{-su} f(u) du + \dots + \infty \\ &= \sum_{n=0}^{\infty} \int_{nT}^{(n+1)T} e^{-su} f(u) du \end{aligned}$$

Let us set $u = t + nT$, then

$$Lf(t) = \sum_{n=0}^{\infty} \int_{t=0}^T e^{-s(t+nT)} f(t+nT) dt$$

Here

$$f(t+nT) = f(t), \text{ by periodic property}$$

Hence

$$Lf(t) = \sum_{n=0}^{\infty} (e^{-sT})^n \int_0^T e^{-st} f(t) dt$$

$$= \left[\frac{1}{1 - e^{-sT}} \right]_0^T \int_0^T e^{-st} f(t) dt, \text{ identifying the above series as a geometric series.}$$

$$\text{Thus } L[f(t)] = \left[\frac{1}{1 - e^{-sT}} \right]_0^T \int_0^T e^{-st} f(t) dt$$

This is the desired result.

Examples:-

1. For the periodic function $f(t)$ of period 4, defined by $f(t) = \begin{cases} 3t, & 0 < t < 2 \\ 6, & 2 < t < 4 \end{cases}$

find $L[f(t)]$

Here, period of $f(t) = T = 4$

We have,

$$\begin{aligned} L f(t) &= \left[\frac{1}{1 - e^{-sT}} \right]_0^T \int_0^T e^{-st} f(t) dt \\ &= \left[\frac{1}{1 - e^{-4s}} \right]_0^4 \int_0^4 e^{-st} f(t) dt \\ &= \frac{1}{1 - e^{-4s}} \left[\int_0^2 3te^{-st} dt + \int_2^4 6e^{-st} dt \right] \\ &= \frac{1}{1 - e^{-4s}} \left[3 \left\{ \left[t \left(\frac{e^{-st}}{-s} \right) \right]_0^2 - \int_0^2 1 \cdot \frac{e^{-st}}{-s} dt \right\} + 6 \left(\frac{e^{-st}}{-s} \right)_2^4 \right] \\ &= \frac{1}{1 - e^{-4s}} \left[\frac{3(-e^{-2s} - 2se^{-4s})}{s^2} \right] \end{aligned}$$

Thus,

$$L[f(t)] = \frac{3(1 - e^{-2s} - 2se^{-4s})}{s^2(1 - e^{-4s})}$$

3. A periodic function of period $\frac{2\pi}{\omega}$ is defined by

$$f(t) = \begin{cases} E \sin \omega t, & 0 \leq t < \frac{\pi}{\omega} \\ 0, & \frac{\pi}{\omega} \leq t \leq \frac{2\pi}{\omega} \end{cases}$$

where E and ω are positive constants. Show that $L f(t) = \frac{E\omega}{(s^2 + \omega^2)(1 - e^{-\pi s/\omega})}$

Sol: Here $T = \frac{2\pi}{\omega}$. Therefore

$$\begin{aligned} L f(t) &= \frac{1}{1 - e^{-s(2\pi/\omega)}} \int_0^{2\pi/\omega} e^{-st} f(t) dt \\ &= \frac{1}{1 - e^{-s(2\pi/\omega)}} \int_0^{\pi/\omega} E e^{-st} \sin \omega t dt \\ &= \frac{E}{1 - e^{-s(2\pi/\omega)}} \left[\frac{e^{-st}}{s^2 + \omega^2} \{ s \sin \omega t - \omega \cos \omega t \} \right]_0^{\pi/\omega} \\ &= \frac{E}{1 - e^{-s(2\pi/\omega)}} \frac{\omega(e^{-s\pi/\omega} + 1)}{s^2 + \omega^2} \\ &= \frac{E\omega(1 + e^{-s\pi/\omega})}{(1 - e^{-s\pi/\omega})(1 + e^{-s\pi/\omega})(s^2 + \omega^2)} \\ &= \frac{E\omega}{(1 - e^{-s\pi/\omega})(s^2 + \omega^2)} \end{aligned}$$

This is the desired result.

3. A periodic function $f(t)$ of period $2a$, $a > 0$ is defined by

$$f(t) = \begin{cases} E, & 0 \leq t \leq a \end{cases}$$

-E, $a < t \leq 2a$

show that $L[f(t)] = \frac{E}{s} \tanh\left(\frac{as}{2}\right)$

$$\begin{aligned}
 \text{Sol: Here } T &= 2a. \text{ Therefore } L[f(t)] = \frac{1}{1 - e^{-2as}} \int_0^{2a} e^{-st} f(t) dt \\
 &= \frac{1}{1 - e^{-2as}} \left[\int_0^a E e^{-st} dt + \int_a^{2a} -E e^{-st} dt \right] \\
 &= \frac{E}{s(1 - e^{-2as})} \left[-e^{-sa} + (e^{-2as} - e^{-as}) \right] \\
 &= \frac{E}{s(1 - e^{-2as})} \left[-e^{-as} \right] \\
 &= \frac{E(1 - e^{-as})^2}{s(1 - e^{-as})(1 + e^{-as})} \\
 &= \frac{E}{s} \left[\frac{e^{as/2} - e^{-as/2}}{e^{as/2} + e^{-as/2}} \right] \\
 &= \frac{E}{s} \tanh\left(\frac{as}{2}\right)
 \end{aligned}$$

This is the result as desired.

Step Function:

In many Engineering applications, we deal with an important discontinuous function $H(t-a)$ defined as follows:

$$H(t-a) = \begin{cases} 0, & t \leq a \\ 1, & t > a \end{cases}$$

where a is a non-negative constant.

This function is known as the unit step function or the Heaviside function. The function is named after the British electrical engineer Oliver Heaviside. The function is also denoted by $u(t-a)$. The graph of the function is shown below:

$$H(t-a) \text{-----}$$

Note that the value of the function suddenly jumps from value zero to the value 1 as $t \rightarrow a$ from the left and retains the value 1 for all $t > a$. Hence the function $H(t-a)$ is called the unit step function.

In particular, when $a=0$, the function $H(t-a)$ become $H(t)$, where

$$H(t) = \begin{cases} 0, & t \leq 0 \\ 1, & t > 0 \end{cases}$$

Transform of step function

$$\begin{aligned} \text{By definition, we have } L[H(t-a)] &= \int_0^{\infty} e^{-st} H(t-a) dt \\ &= \int_0^a e^{-st} 0 dt + \int_a^{\infty} e^{-st} (1) dt \\ &= \frac{e^{-as}}{s} \end{aligned}$$

$$\text{In particular, we have } L H(t) = \frac{1}{s}$$

$$\text{Also, } L^{-1} \left[\frac{e^{-as}}{s} \right] = H(t-a) \quad \text{and} \quad L^{-1} \left(\frac{1}{s} \right) = H(t)$$

Unit step function (Heaviside function)

Statement: - $L[f(t-a)H(t-a)] = e^{-as} Lf(t)$

Proof: - We have

$$\begin{aligned} L [f(t-a) H(t-a)] &= \int_0^{\infty} f(t-a)H(t-a)e^{-st} dt \\ &= \int_a^{\infty} e^{-st} f(t-a)dt \end{aligned}$$

Setting $t-a = u$, we get

$$\begin{aligned} L[f(t-a) H(t-a)] &= \int_0^{\infty} e^{-s(a+u)} f(u)du \\ &= e^{-as} L [f(t)] \end{aligned}$$

This is the desired shift theorem.

Also, $L^{-1} [e^{-as} L f(t)] = f(t-a) H(t-a)$

Examples:

1. Find $L [e^{t-2} + \sin(t-2)] H(t-2)$

Sol: Let $f(t-2) = [e^{t-2} + \sin(t-2)]$

Then $f(t) = [e^t + \sin t]$

so that $L f(t) = \frac{1}{s-1} + \frac{1}{s^2+1}$

By Heaviside shift theorem, we have

$$L[f(t-2) H(t-2)] = e^{-2s} Lf(t)$$

Thus,

$$L[e^{(t-2)} + \sin(t-2)]H(t-2) = e^{-2s} \left[\frac{1}{s-1} + \frac{1}{s^2+1} \right]$$

2. Find $L (3t^2 + 2t + 3) H(t-1)$

Sol: Let $f(t-1) = 3t^2 + 2t + 3$

so that

$$f(t) = 3(t+1)^2 + 2(t+1) + 3 = 3t^2 + 8t + 8$$

Hence

$$L[f(t)] = \frac{6}{s^3} + \frac{8}{s^2} + \frac{8}{s}$$

Thus

$$\begin{aligned} L[3t^2 + 2t + 3] H(t-1) &= L[f(t-1) H(t-1)] \\ &= e^{-s} L[f(t)] \\ &= e^{-s} \left[\frac{6}{s^3} + \frac{8}{s^2} + \frac{8}{s} \right] \end{aligned}$$

3. Find $L\{e^{-t} H(t-2)\}$

Sol: Let $f(t-2) = e^{-t}$, so that, $f(t) = e^{-(t+2)}$

$$\text{Thus, } L[f(t)] = \frac{e^{-2}}{s+1}$$

By shift theorem, we have

$$L[f(t-2)H(t-2)] = e^{-2s} Lf(t) = \frac{e^{-2(s+1)}}{s+1}$$

Thus

$$L\{e^{-t} H(t-2)\} = \frac{e^{-2(s+1)}}{s+1}$$

4. Let $f(t) = \begin{cases} f_1(t), & t \leq a \\ f_2(t), & t > a \end{cases}$

Verify that $f(t) = f_1(t) + [f_2(t) - f_1(t)]H(t-a)$

Sol: Consider

$$f_1(t) + [f_2(t) - f_1(t)]H(t-a) = \begin{cases} f_1(t) + f_2(t) - f_1(t), & t > a \\ 0, & t \leq a \end{cases}$$

$$= \begin{cases} f_2(t), & t > a \\ f_1(t), & t \leq a \end{cases} = f(t), \text{ given}$$

Thus the required result is verified.

5. Express the following functions in terms of unit step function and hence find their Laplace transforms.

$$1. f(t) = \begin{cases} t^2, & 1 < t \leq 2 \\ 4t, & t > 2 \end{cases}$$

Sol: Here, $f(t) = t^2 + (4t - t^2) H(t-2)$

$$\text{Hence, } L f(t) = \frac{2}{s^3} + L(4t - t^2)H(t-2) \quad (i)$$

$$\text{Let } \phi(t-2) = 4t - t^2$$

$$\text{so that } \phi(t) = 4(t+2) - (t+2)^2 = -t^2 + 4$$

$$\text{Now, } L[\phi(t)] = -\frac{2}{s^3} + \frac{4}{s}$$

Expression (i) reads as

$$L f(t) = \frac{2}{s^3} + L \left[(4t - t^2)H(t-2) \right]$$

$$= \frac{2}{s^3} + e^{-2s} L\phi(t)$$

$$= \frac{2}{s^3} + e^{-2s} \left(\frac{4}{s} - \frac{2}{s^3} \right)$$

This is the desired result

3. Find Laplace transform of
$$f(t) = \begin{cases} \cos t, & 0 < t < \pi \\ \sin t, & t > \pi \end{cases}$$

Sol: Here $f(t) = \cos t + (\sin t - \cos t)H(t - \pi)$

Hence,
$$L[f(t)] = \frac{s}{s^2 + 1} + L(\sin t - \cos t)H(t - \pi) \quad (ii)$$

Let $\phi(t - \pi) = \sin t - \cos t$

Then $\phi(t) = \sin(t + \pi) - \cos(t + \pi) = -\sin t + \cos t$

so that
$$L[\phi(t)] = -\frac{1}{s^2 + 1} + \frac{s}{s^2 + 1}$$

Expression (ii) reads as
$$L[f(t)] = \frac{s}{s^2 + 1} + L[(\sin t - \cos t)H(t - \pi)]$$

$$= \frac{s}{s^2 + 1} + e^{-\pi s} L\phi(t)$$

$$= \frac{s}{s^2 + 1} + e^{-\pi s} \left[\frac{s - 1}{s^2 + 1} \right]$$

UNIT IMPULSE FUNCTION

Definition: The unit impulse function denoted by $\delta(t - a)$ is defined as follows

$$\delta(t - a) = \lim_{\epsilon \rightarrow 0} \delta_{\epsilon}(t - a), \quad a \geq 0 \quad \dots(1)$$

Where

$$\delta_{\epsilon}(t - a) = \begin{cases} 0, & \text{if } t < a \\ \frac{1}{\epsilon}, & \text{if } a < t < a + \epsilon \\ 0, & \text{if } t > a + \epsilon \end{cases} \quad \dots(2)$$

The graph of the function $\delta_{\epsilon}(t - a)$ is as shown below:

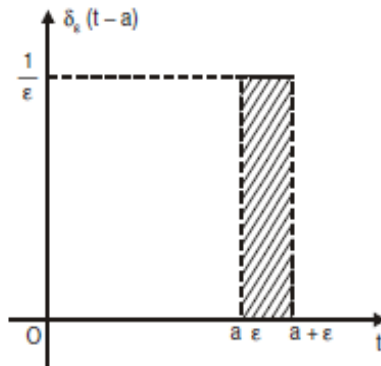

Fig. 7.2

Laplace transform of the unit impulse function

Consider

$$\begin{aligned} L\{\delta_{\epsilon}(t - a)\} &= \int_0^{\infty} e^{-st} \delta_{\epsilon}(t - a) dt \\ &= \int_0^a e^{-st} (0) dt + \int_a^{a+\epsilon} e^{-st} \frac{1}{\epsilon} dt + \int_{a+\epsilon}^{\infty} e^{-st} (0) dt \\ &= \frac{1}{\epsilon} \int_a^{a+\epsilon} e^{-st} dt = \frac{1}{\epsilon} \left[\frac{e^{-st}}{-s} \right]_a^{a+\epsilon} \\ &= -\frac{1}{\epsilon s} \left[e^{-s(a+\epsilon)} - e^{-as} \right] \\ &= e^{-as} \left[\frac{1 - e^{-\epsilon s}}{\epsilon s} \right] \end{aligned}$$

Taking the limits on both sides as $\epsilon \rightarrow 0$, we get,

$$\lim_{\epsilon \rightarrow 0} L\{\delta_{\epsilon}(t - a)\} = e^{-as} \lim_{\epsilon \rightarrow 0} \left[\frac{1 - e^{-\epsilon s}}{\epsilon s} \right]$$

i.e., $L\{\delta(t - a)\} = e^{-as}$ (Using L' Hospital Rule)

If $a = 0$ then $L\{\delta(t)\} = 1$

1. Find the Laplace transforms of the following functions:

(1) $(2t - 1) u(t - 2)$

Solution

(1) Now $2t - 1 = 2(t - 2) + 3$

∴ Using Heaviside shift theorem, we get

$$\begin{aligned} L\{(2t - 1) u(t - 2)\} &= L\{[2(t - 2) + 3] u(t - 2)\} \\ &= e^{-2s} L\{2t + 3\} && \text{Replacing } t - 2 \text{ by } t \\ &= e^{-2s} \{2L(t) + L(3)\} \\ &= e^{-2s} \left\{ \frac{2}{s^2} + \frac{3}{s} \right\}. \end{aligned}$$

(2) $t^2 u(t - 3)$

Solution: $t^2 = [(t - 3) + 3]^2$

$$= (t - 3)^2 + 6(t - 3) + 9$$

Then $L\{t^2 u(t - 3)\} = L\{[(t - 3)^2 + 6(t - 3) + 9] u(t - 3)\}$

Replacing $t - 3$ by t

$$= e^{-3s} L\{t^2 + 6t + 9\}$$

Using Heaviside shift theorem

$$\begin{aligned} &= e^{-3s} \{L(t^2) + 6L(t) + 9L(1)\} \\ &= e^{-3s} \left\{ \frac{2}{s^3} + \frac{6}{s^2} + \frac{9}{s} \right\}. \end{aligned}$$

3. Find $L[2\delta(t - 1) + 3\delta(t - 2) + 4\delta(t + 3)]$.

Solution. We have

$$= 2L\delta(t - 1) + 3L\delta(t - 2) + 4L\delta(t + 3)$$

$$= 2e^{-s} + 3e^{-2s} + 4e^{3s}.$$

Since $L\delta(t - a) = e^{-as}$

4. Find $L[\cosh 3t \delta(t - 2)]$.

Solution

$$\cosh 3t \delta(t - 2) = \frac{1}{2} \{e^{3t} + e^{-3t}\} \delta(t - 2)$$

$$\begin{aligned}
 L[\cosh 3t \delta(t-2)] &= \frac{1}{2} \left\{ L[e^{3t} \delta(t-2)] + L[e^{-3t} \delta(t-2)] \right\} \\
 &= \text{shifting} \qquad \qquad \qquad s-3 \rightarrow s \\
 & \qquad \qquad \qquad \qquad \qquad \qquad s+3 \rightarrow s \\
 &= \frac{1}{2} \left\{ L[\delta(t-2)]_{s \rightarrow s-3} + L[\delta(t-2)]_{s \rightarrow s+3} \right\} \\
 &= \frac{1}{2} \left\{ (e^{-2s})_{s \rightarrow s-3} + (e^{-2s})_{s \rightarrow s+3} \right\} \\
 &= \frac{1}{2} \left\{ e^{-2(s-3)} + e^{-2(s+3)} \right\} \\
 &= \frac{e^{-2s}}{2} \{ e^6 + e^{-6} \} \\
 L[\cosh 3t \delta(t-2)] &= \cosh 6 e^{-2s}
 \end{aligned}$$

The Inverse Laplace Transforms

Introduction:

Let $L[f(t)] = F(s)$. Then $f(t)$ is defined as the inverse Laplace transform of $F(s)$ and is denoted by $L^{-1}F(s)$. Thus $L^{-1}[F(s)] = f(t)$.

Linearity Property

Let $L^{-1}[F(s)] = f(t)$ and $L^{-1}[G(s)] = g(t)$ and a and b be any two constants. Then
 $L^{-1}[aF(s) + bG(s)] = aL^{-1}[F(s)] + bL^{-1}[G(s)]$

Table of Inverse Laplace Transforms

$F(s)$	$f(t) = L^{-1}F(s)$
$\frac{1}{s}, s > 0$	1
$\frac{1}{s-a}, s > a$	e^{at}
$\frac{s}{s^2+a^2}, s > 0$	$\cos at$

$\frac{1}{s^2 + a^2}, s > 0$	$\frac{\text{Sin } at}{a}$
$\frac{1}{s^2 - a^2}, s > a $	$\frac{\text{Sin h } at}{a}$
$\frac{s}{s^2 - a^2}, s > a $	$\text{Cos h } at$
$\frac{1}{s^{n+1}}, s > 0$ $n = 0, 1, 2, 3, \dots$	$\frac{t^n}{n!}$
$\frac{1}{s^{n+1}}, s > 0$ $n > -1$	$\frac{t^n}{\Gamma(n+1)}$

Example

1. Find the inverse Laplace transforms of the following:

(i) $\frac{1}{2s-5}$ (ii) $\frac{s+b}{s^2+a^2}$ (iii) $\frac{2s-5}{4s^2+25} + \frac{4s-9}{9-s^2}$

Here

$$(i) \quad L^{-1}\left[\frac{1}{2s-5}\right] = \frac{1}{2} L^{-1}\left[\frac{1}{s-\frac{5}{2}}\right] = \frac{1}{2} e^{\frac{5t}{2}}$$

$$(ii) \quad L^{-1}\left[\frac{s+b}{s^2+a^2}\right] = L^{-1}\left[\frac{s}{s^2+a^2}\right] + b L^{-1}\left[\frac{1}{s^2+a^2}\right] = \cos at + \frac{b}{a} \sin at$$

$$(iii) \quad L^{-1}\left[\frac{2s-5}{4s^2+25} + \frac{4s-8}{9-s^2}\right] = \frac{2}{4} L^{-1}\left[\frac{s-\frac{5}{2}}{s^2+\frac{25}{4}}\right] - 4L^{-1}\left[\frac{s-\frac{9}{2}}{s^2-9}\right]$$

$$= \frac{1}{2} \left[\cos \frac{5t}{2} - \sin \frac{5t}{2} \right] - 4 \left[\cos h3t - \frac{3}{2} \sin h3t \right]$$

Evaluation of $L^{-1} F(s - a)$

We have, if $L[f(t)] = F(s)$, then $L[e^{at} f(t)] = F(s - a)$, and so

$$L^{-1}[F(s - a)] = e^{at} f(t) = e^{at} L^{-1}[F(s)]$$

Examples

1. Evaluate: $L^{-1} \left[\frac{3s+1}{s+1} \right]$

$$\begin{aligned} \text{Given} &= L^{-1} \left[\frac{3(s+1-1)+1}{s+1} \right] = 3 L^{-1} \left[\frac{1}{s+1} \right] - 2 L^{-1} \left[\frac{1}{s+1} \right] \\ &= 3e^{-t} L^{-1} \left[\frac{1}{s^3} \right] - 2e^{-t} L^{-1} \left[\frac{1}{s^4} \right] \end{aligned}$$

Using the formula

$$L^{-1} \left[\frac{1}{s^{n+1}} \right] = \frac{t^n}{n!} \quad \text{and taking } n = 2 \text{ and } 3, \text{ we get}$$

$$\text{Given} = \frac{3e^{-t}t^2}{2} - \frac{e^{-t}t^3}{3}$$

2. Evaluate: $L^{-1} \left[\frac{s+2}{s^2-2s+5} \right]$

$$\begin{aligned} \text{Given} &= L^{-1} \left[\frac{s+2}{(s-1)^2+4} \right] = L^{-1} \left[\frac{(s-1)+3}{(s-1)^2+4} \right] \\ &= L^{-1} \left[\frac{s-1}{(s-1)^2+4} \right] + 3L^{-1} \left[\frac{1}{(s-1)^2+4} \right] \end{aligned}$$

$$= e^t L^{-1} \left[\frac{s}{s^2 + 4} \right] + 3 e^t L^{-1} \left[\frac{1}{s^2 + 4} \right]$$

$$= e^t \cos 2t + \frac{3}{2} e^t \sin 2t$$

3. Evaluate : $L^{-1} \left[\frac{2s+1}{s^2+3s+1} \right]$

$$\text{Given} = 2L^{-1} \left[\frac{\left(s + \frac{3}{2} \right) - 1}{\left(s + \frac{3}{2} \right) - \frac{5}{4}} \right] = 2 \left[L^{-1} \left[\frac{\left(s + \frac{3}{2} \right)}{\left(s + \frac{3}{2} \right) - \frac{5}{4}} \right] - L^{-1} \left[\frac{1}{\left(s + \frac{3}{2} \right) - \frac{5}{4}} \right] \right]$$

$$= 2 \left[e^{-\frac{3t}{2}} L^{-1} \left[\frac{s}{s^2 - \frac{5}{4}} \right] - e^{-\frac{3t}{2}} L^{-1} \left[\frac{1}{s^2 - \frac{5}{4}} \right] \right]$$

$$= 2e^{-\frac{3t}{2}} \left[\cos h \frac{\sqrt{5}}{2} t \frac{2}{\sqrt{5}} \sin h \frac{\sqrt{5}}{2} t \right]$$

4. Evaluate: $L^{-1} \left[\frac{2s^2 + 5s - 4}{s^3 + s^2 - 2s} \right]$

we have

$$\frac{2s^2 + 5s - 4}{s^3 + s^2 - 2s} = \frac{2s^2 + 5s - 4}{s(s^2 + s - 2)}$$

$$= \frac{2s^2 + 5s - 4}{s(s+2)(s-1)}$$

$$= \frac{A}{s} + \frac{B}{s+2} + \frac{C}{s-1}$$

$$\text{Then } 2s^2 + 5s - 4 = A(s+2)(s-1) + Bs(s-1) + Cs(s+2)$$

For $s = 0$, we get $A = 2$, for $s = 1$, we get $C = 1$ and for $s = -2$, we get $B = -1$. Using these values in (1), we get

$$\frac{2s^2 + 5s - 4}{s^3 + s^2 - 2s} = \frac{2}{s} - \frac{1}{s+2} + \frac{1}{s-1}$$

Hence

$$L^{-1} \left[\frac{2s^2 + 5s - 4}{s^3 + s^2 - 2s} \right] = 2 - e^{-2t} + e^t$$

5. Evaluate: $L^{-1} \left[\frac{4s+5}{(s+1)(s+2)} \right]$

Let us take

$$\frac{4s+5}{(s+1)(s+2)} = \frac{A}{s+1} + \frac{B}{s+1} + \frac{C}{s+2}$$

$$\text{Then } 4s + 5 = A(s+2) + B(s+1)(s+2) + C(s+1)^2$$

For $s = -1$, we get $A = 1$, for $s = -2$, we get $C = -3$

Comparing the coefficients of s^2 , we get $B + C = 0$, so that $B = 3$. Using these values in

$$(1), \text{ we get } \frac{4s+5}{(s+1)(s+2)} = \frac{1}{s+1} + \frac{3}{s+1} - \frac{3}{s+2}$$

$$\begin{aligned} \text{Hence } L^{-1} \left[\frac{4s+5}{(s+1)(s+2)} \right] &= e^{-t} L^{-1} \left[\frac{1}{s^2} \right] + 3e^{-t} L^{-1} \left[\frac{1}{s} \right] - 3e^{-2t} L^{-1} \left[\frac{1}{s} \right] \\ &= te^{-t} + 3e^{-t} - 3e^{-2t} \end{aligned}$$

6. Evaluate: $L^{-1} \left[\frac{s^3}{s^4 - a^4} \right]$

$$\text{Let } \frac{s^3}{s^4 - a^4} = \frac{A}{s-a} + \frac{B}{s+a} + \frac{Cs+D}{s^2+a^2} \quad (1)$$

$$\text{Hence } s^3 = A(s+a)(s^2+a^2) + B(s-a)(s^2+a^2) + (Cs+D)(s^2-a^2)$$

For $s = a$, we get $A = 1/4$; for $s = -a$, we get $B = 1/4$; comparing the constant terms, we get

$D = a(A-B) = 0$; comparing the coefficients of s^3 , we get

$1 = A + B + C$ and so $C = \frac{1}{2}$. Using these values in (1), we get

$$\frac{s^3}{s^4 - a^4} = \frac{1}{4} \left[\frac{1}{s-a} + \frac{1}{s+a} \right] + \frac{1}{2} \frac{s}{s^2 + a^2}$$

Taking inverse transforms, we get

$$\begin{aligned} L^{-1} \left[\frac{s^3}{s^4 - a^4} \right] &= \frac{1}{4} \left[e^{at} + e^{-at} \right] + \frac{1}{2} \cos at \\ &= \frac{1}{2} \left[\cosh at + \cos at \right] \end{aligned}$$

7. Evaluate $L^{-1} \left[\frac{s}{s^4 + s^2 + 1} \right]$

$$\begin{aligned} \text{Consider } \frac{s}{s^4 + s^2 + 1} &= \frac{s}{(s^2 + s + 1)(s^2 - s + 1)} = \frac{1}{2} \left[\frac{2s}{(s^2 + s + 1)(s^2 - s + 1)} \right] \\ &= \frac{1}{2} \left[\frac{(s^2 + s + 1) - (s^2 - s + 1)}{(s^2 + s + 1)(s^2 - s + 1)} \right] \\ &= \frac{1}{2} \left[\frac{1}{s^2 - s + 1} - \frac{1}{s^2 + s + 1} \right] \\ &= \frac{1}{2} \left[\frac{1}{\left(s - \frac{1}{2}\right)^2 + \frac{3}{4}} - \frac{1}{\left(s + \frac{1}{2}\right)^2 + \frac{3}{4}} \right] \end{aligned}$$

Therefore

$$L^{-1} \left[\frac{s}{s^4 + s^2 + 1} \right] = \frac{1}{2} \left[e^{\frac{1}{2}t} L^{-1} \left[\frac{1}{s^2 + \frac{3}{4}} \right] - e^{-\frac{1}{2}t} L^{-1} \left[\frac{1}{s^2 + \frac{3}{4}} \right] \right]$$

$$= \frac{1}{2} \left[e^{\frac{1}{2}t} \frac{\sin \frac{\sqrt{3}}{2}t}{\frac{\sqrt{3}}{2}} - e^{-\frac{1}{2}t} \frac{\sin \frac{\sqrt{3}}{2}t}{\frac{\sqrt{3}}{2}} \right]$$

$$= \frac{2}{\sqrt{3}} \sin \left(\frac{\sqrt{3}}{2}t \right) \sin h \left(\frac{t}{2} \right)$$

Evaluation of $L^{-1}[e^{-as} F(s)]$

We have, if $L[f(t)] = F(s)$, then $L[f(t-a)H(t-a)] = e^{-as} F(s)$, and so

$$L^{-1}[e^{-as} F(s)] = f(t-a)H(t-a)$$

Examples

(1) Evaluate: $L^{-1} \left[\frac{e^{-5s}}{(s-2)^4} \right]$

Here

$$a = 5, F(s) = \frac{1}{(s-2)^4}$$

$$\text{Therefore } f(t) = L^{-1}F(s) = L^{-1} \frac{1}{(s-2)^4} = e^{2t} L^{-1} \frac{1}{s^4} = \frac{e^{2t} t^3}{6}$$

Thus

$$L^{-1} \frac{e^{-5s}}{(s-2)^4} = f(t-a)H(t-a)$$

$$= \frac{e^{2(t-5)} (t-5)^3}{6} H(t-5)$$

(2) Evaluate: $L^{-1} \left[\frac{e^{-\pi s}}{s^2+1} + \frac{se^{-2\pi s}}{s^2+4} \right]$

$$\text{Given} = f_1 \mathcal{H}(-\pi) + f_2 \mathcal{H}(-2\pi) \quad (1)$$

$$\text{Here } f_1(t) = L^{-1} \frac{1}{s^2 + 1} = \sin t$$

$$f_2(t) = L^{-1} \frac{s}{s^2 + 4} = \cos 2t$$

Now relation (1) reads as

$$\begin{aligned} \text{Given} &= \sin \mathcal{H}(-\pi) + \cos 2 \mathcal{H}(-2\pi) \\ &= -\cos t \mathcal{H}(-\pi) + \cos 2t \mathcal{H}(-2\pi) \end{aligned}$$

Inverse transform of logarithmic functions

We have, if $L f(t) = F(s)$, then $L \left[-\frac{d}{ds} F(s) \right] = t f(t)$

$$\text{Hence } L^{-1} \left(-\frac{d}{ds} F(s) \right) = t f(t)$$

Examples:

$$(1) \text{ Evaluate: } L^{-1} \log \left(\frac{s+a}{s+b} \right)$$

$$\text{Let } F(s) = \log \left(\frac{s+a}{s+b} \right) = \log(s+a) - \log(s+b)$$

$$\text{Then } -\frac{d}{ds} F(s) = -\left[\frac{1}{s+a} - \frac{1}{s+b} \right]$$

$$\text{So that } L^{-1} \left[-\frac{d}{ds} F(s) \right] = -\left[e^{-at} - e^{-bt} \right]$$

$$\text{or } t f(s) = e^{-bt} - e^{-at}$$

$$\text{Thus } f(s) = \frac{e^{-bt} - e^{-at}}{b}$$

(2) Evaluate $L^{-1} \tan^{-1}\left(\frac{a}{s}\right)$

$$\text{Let } F(s) = \tan^{-1}\left(\frac{a}{s}\right)$$

$$\text{Then } -\frac{d}{ds} F \Leftrightarrow \left[\frac{a}{s^2 + a^2} \right]$$

$$\text{or } L^{-1}\left[-\frac{d}{ds} F\right] = \sin at \quad \text{so that}$$

$$\text{or } t f \Leftrightarrow \sin at$$

$$f \Leftrightarrow \frac{\sin at}{a}$$

Inverse transform of $\left[\frac{F s}{s} \right]$

(1) Evaluate: $L^{-1} \left[\frac{1}{s^2 + a^2} \right]$

Sol: Let us denote $F s = \frac{1}{s^2 + a^2}$ so that

$$f(t) = L^{-1} F s = \frac{\sin at}{a}$$

$$\text{Then } L^{-1} \frac{1}{s^2 + a^2} = L^{-1} \frac{F s}{s} = \int_0^t \frac{\sin at}{a} dt$$

$$= \frac{1 - \cos at}{a^2}$$

Convolution Theorem:

If $L^{-1}\{F(s)\} = f(t)$ and $L^{-1}\{G(s)\} = g(t)$

then $L^{-1}\{F(s) G(s)\} = \int_0^t f(u) g(t-u) du$... (1)

Proof. Since $L^{-1} F(s) = f(t)$ and $L^{-1}\{G(s)\} = g(t)$

we have $F(s) = L\{f(t)\} = \int_0^{\infty} e^{-st} f(t) dt$

and $G(s) = L\{g(t)\} = \int_0^{\infty} e^{-st} g(t) dt$

To prove (1), it is sufficient to prove that

$$L\left\{\int_0^t f(u) g(t-u) du\right\} = F(s) G(s) \quad \dots(2)$$

Consider

$$\begin{aligned} L\left\{\int_0^t f(u) g(t-u) du\right\} &= \int_0^{\infty} e^{-st} \left\{\int_0^t f(u) g(t-u) du\right\} dt \\ &= \int_{t=0}^{\infty} \int_{u=0}^t e^{-st} f(u) g(t-u) du dt \quad \dots(3) \end{aligned}$$

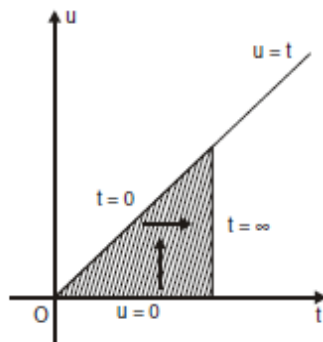

Fig. 8.1

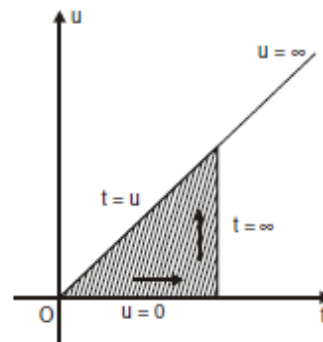

Fig. 8.2

The domain of integration for the above double integral is from $u = 0$ to $u = t$ and $t = 0$ to $t = \infty$ which is as shown in Fig. 8.1.

The double integral given in the R.H.S. of equation (3) indicates that we integrate first parallel to u -axis and then parallel to t -axis.

We shall now change the order of integration parallel to t -axis the limits being $t = u$ to $t = \infty$ and parallel to u -axis the limits being $u = 0$ to $u = \infty$.

\therefore From equation (3), we get

$$\begin{aligned} L\left\{\int_0^t f(u) g(t-u) du\right\} &= \int_0^{\infty} f(u) \left\{\int_u^{\infty} e^{-st} g(t-u) dt\right\} du \\ &= \int_0^{\infty} f(u) e^{-su} \left\{\int_u^{\infty} e^{-s(t-u)} g(t-u) dt\right\} du \end{aligned}$$

Substitute $t - u = v$ so that $dt = dv$

when $t = u$, $v = 0$, and when $t = \infty$, $v = \infty$

$$\begin{aligned} L \left\{ \int_0^t f(u) g(t-u) du \right\} &= \int_0^\infty f(u) e^{-su} \left\{ \int_0^\infty e^{-sv} g(v) dv \right\} du \\ &= \int_0^\infty f(u) e^{-su} G(s) du \\ &= G(s) \int_0^\infty e^{-su} f(u) du \\ &= G(s) \cdot F(s) \end{aligned}$$

$$\therefore L^{-1} \{F(s) G(s)\} = \int_0^t f(u) g(t-u) du$$

This completes the proof of the theorem.

Using Convolution theorem find the inverse laplace transforms

$$(i) \frac{1}{s^2 (s+1)^2}$$

Solution

$$(i) \text{ Let } F(s) = \frac{1}{(s+1)^2}, \quad G(s) = \frac{1}{s^2}$$

$$\text{Then } L^{-1} \{F(s)\} = L^{-1} \left\{ \frac{1}{(s+1)^2} \right\} = t e^{-t} = f(t) \text{ (say)}$$

$$L^{-1} \{G(s)\} = L^{-1} \left\{ \frac{1}{s^2} \right\} = t = g(t) \text{ say}$$

Then by Convolution theorem, we have

$$L^{-1} \{F(s) G(s)\} = \int_0^t f(u) g(t-u) du$$

$$\begin{aligned} L^{-1} \left\{ \frac{1}{s^2 (s+1)^2} \right\} &= \int_0^t u e^{-u} (t-u) du \\ &= \int_0^t (ut - u^2) e^{-u} du \end{aligned}$$

(2) Evaluate: $L^{-1} \left[\frac{1}{s^2 + a^2} \right]$

Solution: we have $L^{-1} \frac{1}{s + a} = e^{-at}$

Hence $L^{-1} \frac{1}{s^2 + a^2} = \int_0^t e^{-at} dt$

$$= \frac{1}{a^2} [1 - e^{-at} + at], \text{ on integration by parts.}$$

Using this, we get

$$L^{-1} \frac{1}{s^2 + a^2} = \frac{1}{a^2} \int_0^t [1 - e^{-at} + at] dt$$

$$= \frac{1}{a^3} [at + e^{-at} + 2e^{-at} - 1]$$

Inverse transform of F(s) by using convolution theorem :

We have, if $L(f(t)) = F(s)$ and $L(g(t)) = G(s)$, then

$$L[f(t) * g(t)] = Lf(t) \cdot Lg(t) = F(s) G(s) \text{ and so}$$

$$L^{-1}[F(s) G(s)] = f(t) * g(t) = \int_0^t f(t-u) g(u) du$$

This expression is called the convolution theorem for inverse Laplace transform

Examples

Employ convolution theorem to evaluate the following:

$$(1) L^{-1} \left[\frac{1}{(s+a)(s+b)} \right]$$

Sol: Let us denote $F(s) = \frac{1}{s+a}$, $G(s) = \frac{1}{s+b}$

Taking the inverse, we get $f(t) = e^{-at}$, $g(t) = e^{-bt}$

Therefore, by convolution theorem,

$$\begin{aligned} L^{-1} \left[\frac{1}{(s+a)(s+b)} \right] &= \int_0^t e^{-a(t-u)} e^{-bu} du = e^{-at} \int_0^t e^{(a-b)u} du \\ &= e^{-at} \left[\frac{e^{(a-b)u} - 1}{a-b} \right] \\ &= \frac{e^{-bt} - e^{-at}}{a-b} \end{aligned}$$

$$(2) L^{-1} \left[\frac{s}{s^2 + a^2} \right]$$

Sol: Let us denote $F(s) = \frac{1}{s^2 + a^2}$, $G(s) = \frac{s}{s^2 + a^2}$ Then

$$f(t) = \frac{\sin at}{a}, g(t) = \cos at$$

Hence by convolution theorem,

$$L^{-1} \frac{s}{s^2 + a^2} = \int_0^t \frac{1}{a} \sin a(t-u) \cos au \, du$$

$$= \frac{1}{a} \int_0^t \frac{\sin at + \sin at - 2au}{2} \, du, \quad \text{by using compound angle formula}$$

$$= \frac{1}{2a} \left[u \sin at - \frac{\cos at - 2au}{-2a} \right]_0^t = \frac{t \sin at}{2a}$$

(3) $L^{-1} \frac{s}{(s-1)(s^2+1)}$

Sol:

$$F(s) = \frac{1}{s-1}, \quad G(s) = \frac{s}{s^2+1}$$

Therefore

$$f(t) = e^t, \quad g(t) = \sin t$$

By convolution theorem, we have

$$L^{-1} \frac{1}{(s-1)(s^2+1)} = \int e^{t-u} \sin u \, du = e^t \left[\frac{e^{-u}}{2} (\sin u - \cos u) \right]_0^t$$

$$= \frac{e^t}{2} \left[-\sin t - \cos t - (-1) \right] = \frac{1}{2} \left[-\sin t - \cos t + 1 \right]$$

LAPLACE TRANSFORM METHOD FOR DIFFERENTIAL EQUATIONS

As noted earlier, Laplace transform technique is employed to solve initial-value problems. The solution of such a problem is obtained by using the Laplace Transform of the derivatives of function and then the inverse Laplace Transform.

The following are the expressions for the derivatives derived earlier.

$$L[f'(t)] = s L f(t) - f(0)$$

$$L[f''(t)] = s^2 L f(t) - s f(0) - f'(0)$$

$$L[f'''(t)] = s^3 L f(t) - s^2 f(0) - s f'(0) - f''(0)$$

1. Solve by using Laplace transform method $y' + y = t e^{-t}$, $y(0) = 2$

Sol: Taking the Laplace transform of the given equation, we get

$$L[y'] + L[y] = L[t e^{-t}]$$

$$(s+1)Y - 2 = \frac{1}{(s+1)^2}$$

so that

$$L[y] = \frac{2s^2 + 4s + 3}{(s+1)^2}$$

Taking the inverse Laplace transform, we get

$$Y = L^{-1} \frac{2s^2 + 4s + 3}{(s+1)^2}$$

$$= L^{-1} \left[\frac{2(s+1-1)^2 + 4(s+1-1) + 3}{(s+1)^2} \right]$$

$$= L^{-1} \left[\frac{2}{s+1} + \frac{1}{(s+1)^2} \right]$$

$$= \frac{1}{2} e^{-t} (t^2 + 4)$$

This is the solution of the given equation.

2. Solve by using Laplace transform method:

$$y'' + 2y' - 3y = \sin t, \quad y(0) = y'(0) = 0$$

Sol: Taking the Laplace transform of the given equation, we get

$$[s^2 Ly(t) - sy(0) - y'(0)] + 2[sLy(t) - y(0)] - 3Ly(t) = \frac{1}{s^2 + 1}$$

Using the given conditions, we get

$$Ly(t) [s^2 + 2s - 3] = \frac{1}{s^2 + 1}$$

or

$$Ly(t) = \frac{1}{(s-1)(s+3)(s^2+1)}$$

or

$$y(t) = L^{-1} \left[\frac{1}{(s-1)(s+3)(s^2+1)} \right]$$

$$= L^{-1} \left[\frac{A}{s-1} + \frac{B}{s+3} + \frac{Cs+D}{s^2+1} \right]$$

$$= L^{-1} \left[\frac{1}{8} \frac{1}{s-1} - \frac{1}{40} \frac{1}{s+3} + \frac{-\frac{s}{10} - \frac{1}{5}}{s^2+1} \right]$$

by using the method of partial sums,

$$= \frac{1}{8} e^t - \frac{1}{40} e^{-3t} - \frac{1}{10} (\cos t + 2 \sin t)$$

This is the required solution of the given equation.

3) Employ Laplace Transform method to solve the integral equation.

$$f(t) = 1 + \int_0^t f(u) \sin(t-u) du$$

Sol: Taking Laplace transform of the given equation, we get

$$L f(t) = \frac{1}{s} + L \int_0^t f(u) \sin(t-u) du$$

By using convolution theorem, here, we get

$$L f(t) = \frac{1}{s} + L f(t) \cdot L \sin t = \frac{1}{s} + \frac{L f(t)}{s^2 + 1}$$

Thus

$$L f(t) = \frac{s^2 + 1}{s^3} \quad \text{or} \quad f(t) = L^{-1} \left(\frac{s^2 + 1}{s^3} \right) = 1 + \frac{t^2}{2}$$

This is the solution of the given integral equation.

(4) A particle is moving along a path satisfying, the equation $\frac{d^2x}{dt^2} + 6\frac{dx}{dt} + 25x = 0$ where

x denotes the displacement of the particle at time t . If the initial position of the particle is at $x = 20$

and the initial speed is 10, find the displacement of the particle at any time t using Laplace transforms.

Sol: Given equation may be rewritten as

$$x''(t) + 6x'(t) + 25x(t) = 0$$

Here the initial conditions are $x(0) = 20$, $x'(0) = 10$.

Taking the Laplace transform of the equation, we get

$$L_x(t) [s^2 + 6s + 25] - 20s - 130 = 0 \quad \text{or}$$

$$L_x(t) = \frac{20s + 130}{s^2 + 6s + 25}$$

so that

$$x(t) = L^{-1} \left[\frac{20s + 130}{s^2 + 6s + 25} \right]$$

$$= L^{-1} \left[\frac{20(s+3) + 70}{(s+3)^2 + 16} \right]$$

$$= 20 L^{-1} \left[\frac{s+3}{(s+3)^2 + 16} \right] + 70 L^{-1} \left[\frac{1}{(s+3)^2 + 16} \right]$$

$$= 20 e^{-3t} \cos 4t + 35 \frac{e^{-3t} \sin 4t}{2}$$

This is the desired solution of the given problem.

(5) A voltage Ee^{-at} is applied at $t = 0$ to a circuit of inductance L and resistance R . Show that the

$$\text{current at any time } t \text{ is } \frac{E}{R - aL} \left[e^{-at} - e^{-\frac{Rt}{L}} \right]$$

Sol: The circuit is an LR circuit. The differential equation with respect to the circuit is

$$L \frac{di}{dt} + Ri = E(t)$$

Here L denotes the inductance, i denotes current at any time t and $E(t)$ denotes the E.M.F.

It is given that $E(t) = E e^{-at}$. With this, we have

Thus, we have

$$L \frac{di}{dt} + Ri = Ee^{-at} \quad \text{or}$$

$$Li'(t) + R i(t) = Ee^{-at}$$

$$L \left[L_T^{-1} i'(t) \right] + R \left[L_T^{-1} i(t) \right] = E L_T^{-1} \left(e^{-at} \right) \quad \text{or}$$

Taking Laplace transform (L_T) on both sides, we get

$$L \left[L_T i(t) - i(0) \right] + R \left[L_T i(t) \right] = E \frac{1}{s+a}$$

$$\text{Since } i(0) = 0, \text{ we get } L_T i(t) \left[L + R \right] = \frac{E}{s+a} \quad \text{or}$$

$$L_T i(t) = \frac{E}{(s+a)(L+R)}$$

$$\text{Taking inverse transform } L, \text{ we get } i(t) = L_T^{-1} \frac{E}{(s+a)(sL+R)}$$

$$= \frac{E}{R-aL} \left[L_T^{-1} \frac{1}{s+a} - L_T^{-1} \frac{1}{sL+R} \right]$$

Thus

$$i(t) = \frac{E}{R-aL} \left[e^{-at} - e^{-\frac{Rt}{L}} \right]$$

This is the result as desired.

(6) Solve the simultaneous equations for x and y in terms of t given $\frac{dx}{dt} + 4y = 0,$

$$\frac{dy}{dt} - 9x = 0 \text{ with } x(0) = 2, y(0) = 1.$$

Sol: Taking Laplace transforms of the given equations, we get

$$\begin{aligned} Lx(t) - x(0) + 4Ly(t) &= 0 \\ -9Lx(t) + Ly(t) - y(0) &= 0 \end{aligned}$$

Using the given initial conditions, we get

$$\begin{aligned} sLx(t) + 4Ly(t) &= 2 \\ -9Lx(t) + 5Ly(t) &= 1 \end{aligned}$$

Solving these equations for $Ly(t)$, we get

$$Ly(t) = \frac{s+18}{s^2+36}$$

so that

$$\begin{aligned} y(t) &= L^{-1} \left[\frac{s}{s^2+36} + \frac{18}{s^2+36} \right] \\ &= \cos 6t + 3 \sin 6t \end{aligned} \quad (1)$$

Using this in $\frac{dy}{dt} - 9x = 0$, we get

$$x(t) = \frac{1}{9} [6 \sin 6t + 18 \cos 6t]$$

or

$$x(t) = \frac{2}{3} [\cos 6t - \sin 6t] \quad (2)$$

(1) and (2) together represents the solution of the given equation.