

(3)

Communication Process :

Transmission of information from one point to another point.

Communication System,

Elements of a communication system

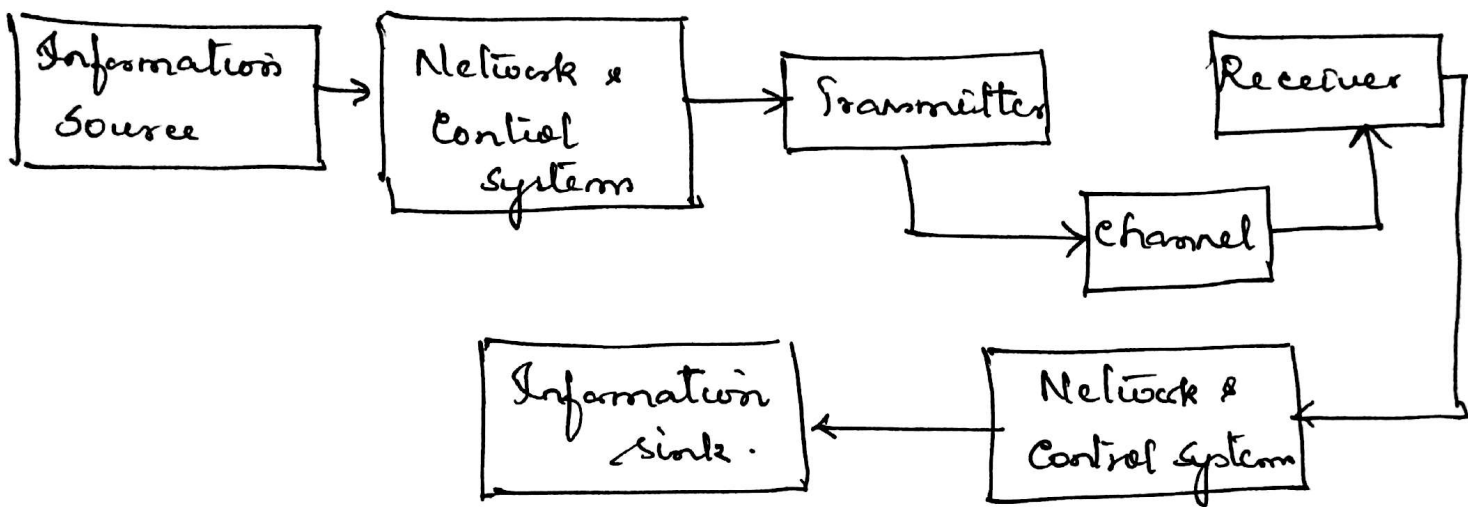

i) Information source: Voice, music, pictures, videos or data files.

ii) Transmitter: It processes the information provided by the source and converts it into a form suitable for transmission over the channel.

Eg: Music signal is converted into FM signal for radio transmission.

iii) channel / transmission medium:

It may be a cable, an optical fiber or free space if using radio or infrared communication.

(4)

iv) Receiver:

It processes the transmitted signal and converts it into a form suitable for intended destination.

It is the inverse of the transmitter. It performs the following functions:

- processing of information
- Conversion
- Compensation for distortion induced in the channel.
- Synchronization of the receiver to the transmitter.

v) Destination / Information sink:

It is the place where the intended information is delivered.

Network and control layers:

They are not present in communication systems with single transmitter and the receiver.

In Internet and cellular telephone systems, with a large number of transmitters and receivers which share the same physical medium, the network and control layers permit the multiplicity of terminals to reliably and efficiently share the same physical medium.

25

Layered Approach of communication system

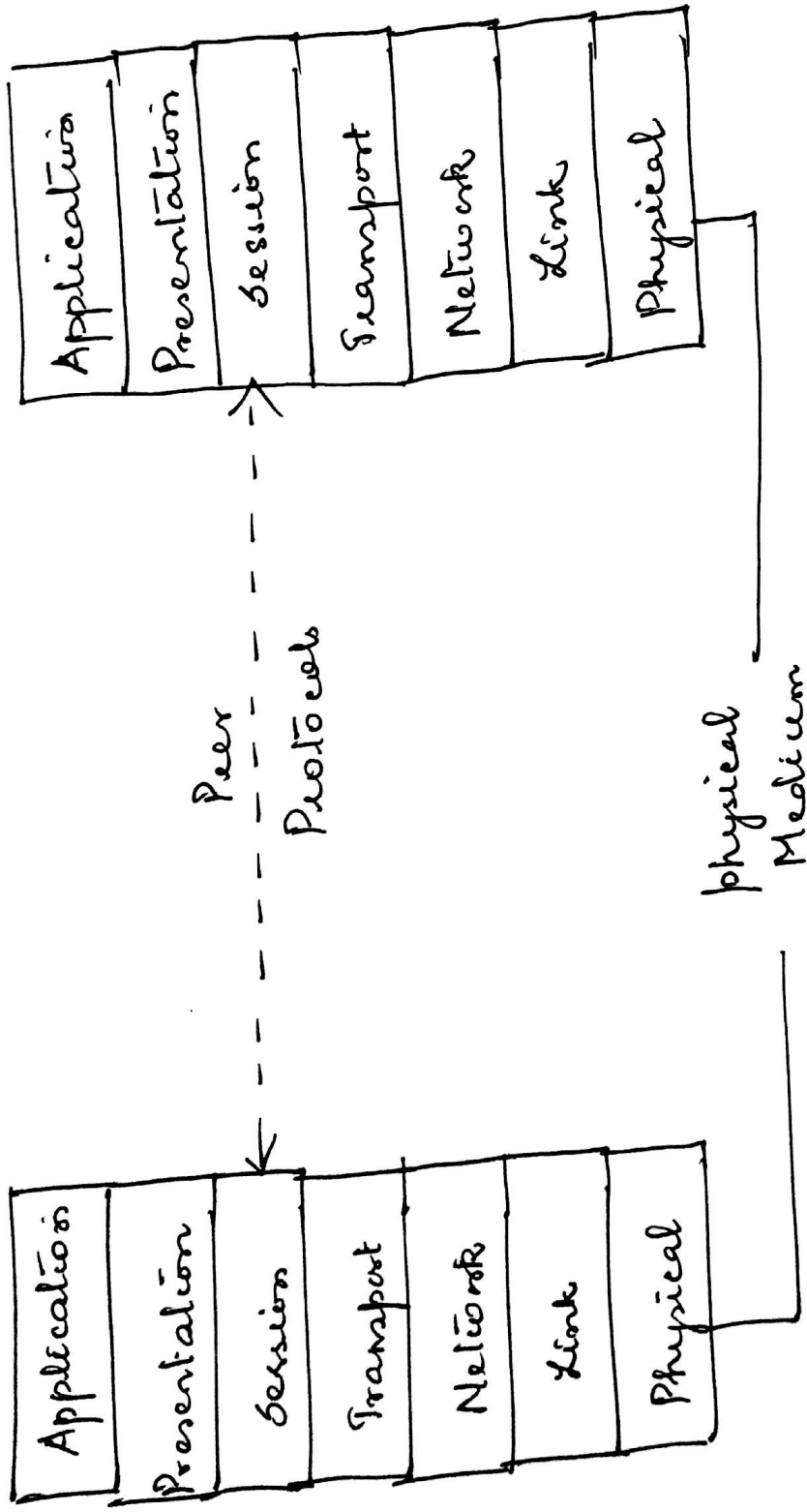

Peer processes in seven-layer OSI model for computer communication

(6)

- * Modern communication systems are analyzed as a sequence of layers.
- * Concept of layering is illustrated by the open system Interconnect (OSI) for computer communications.
- * It is a seven-layer model.
- * Two layered stacks represent two communication nodes.
Ex: sender and Receiver.
- * Each layer of the stack represent a protocol.
- * Peer layers, It communicates virtually by sending messages down the stack on one side across the physical medium and up the stack on the other side.
- * This layered model is best suited to digital communication.
- * Three central layers transmitter, channel and the receiver are referred to as the physical layer.

Example: WIRELESS COMMUNICATIONS

i) protocol stack:-

* packages the data.

* It crosses the radio link (data)

* It reaches the desired destination (data)

Illustration of a Radio Transmitter

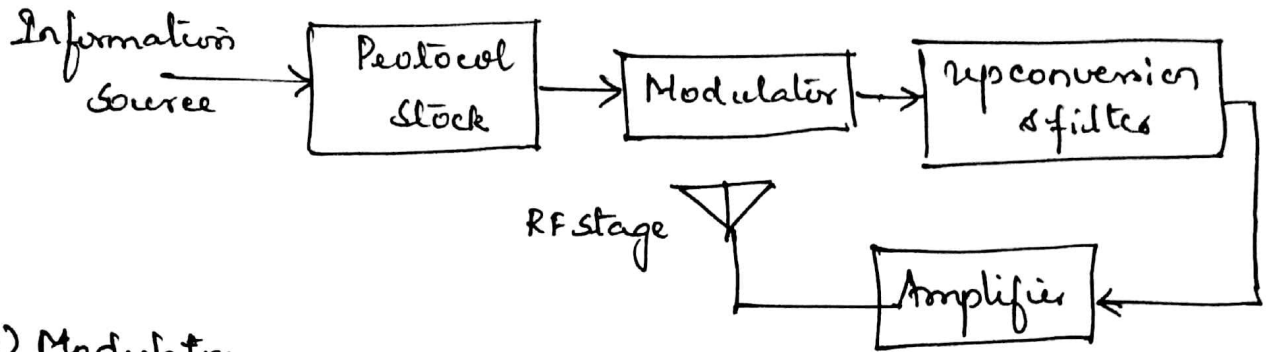

i) Modulator:

The information signal can be impressed upon a carrier frequency so that it can be suitably recovered at the receiving end.

iii) up conversion stage: Modulated signal is converted into the final radio frequency (RF).

iv) RF stage: The signal is amplified at the RF stage to an appropriate power level.

It is then emitted via an antenna. In this process, the electrical signal representing the modulated signal is converted into an electromagnetic wave.

Illustration of Radio Receiver

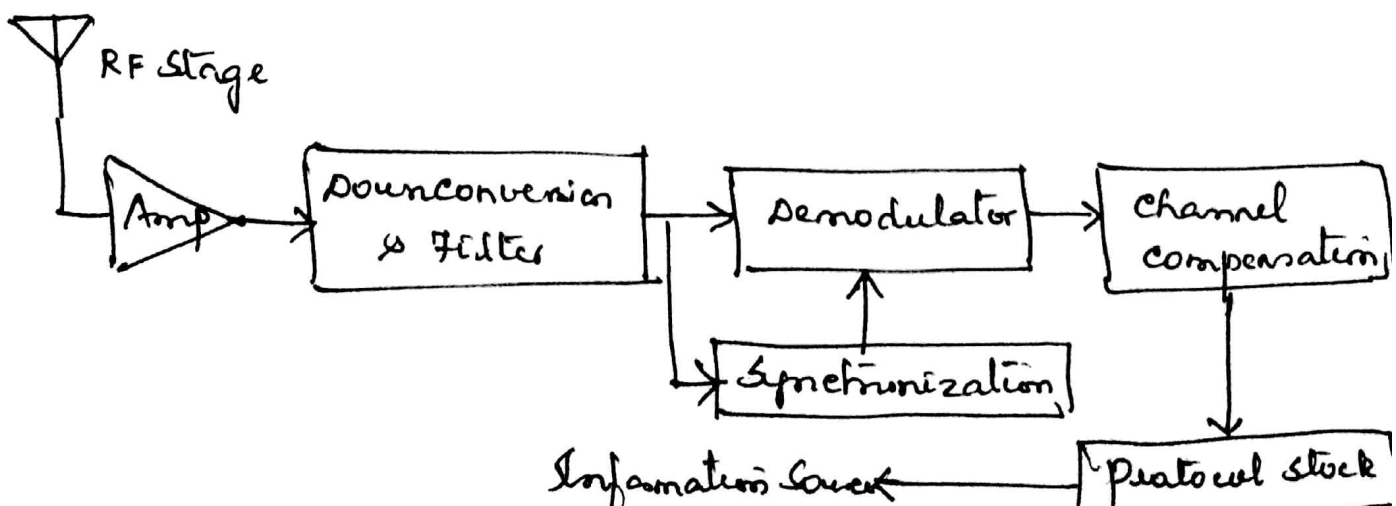

(8)

i) RF stage: It collects the RF energy in the desired frequency band and boosts the signal power to a level where it can be processed easily while minimizing the noise introduced. It is done by low noise amplifiers.

ii) Down conversion: It filters and translates the RF signal to a frequency where the message signal may be more easily demodulated.

iii) Demodulation: In this stage, transmitted message signal can be recovered.

iv) Synchronization: It is achieved by phases locked loop. It is needed because of the difference between the time and frequency clocks at the transmitter and receiver.

v) Channel compensation:

It needs some compensation due to the losses occurred due to the channel impairments. Equalization is needed for frequency selective channels and forward error correction for noisy channels.

vi) Protocol stack:

At this stage, the receiver determines whether the detected message was intended for it or not.

(9)

Illustration of channel impairments

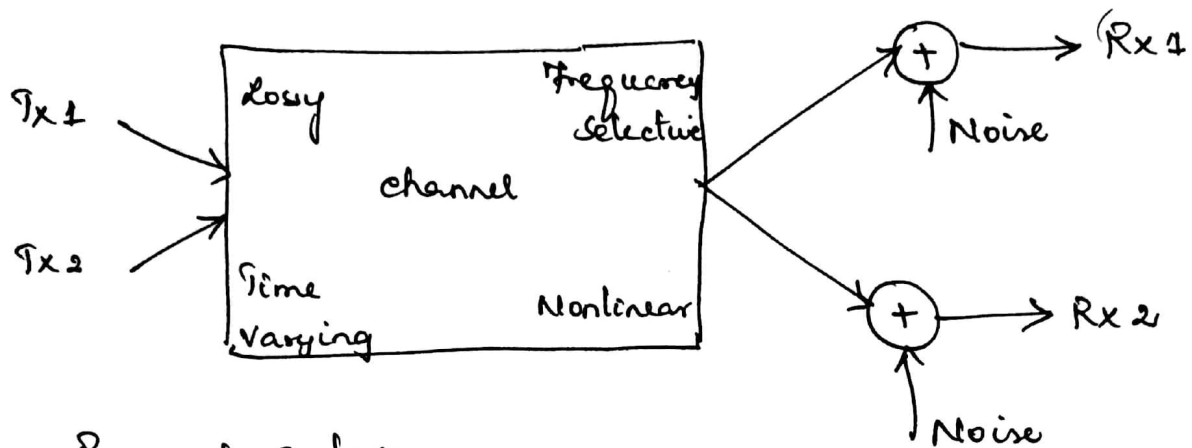

i) Propagation loss:

In free space, received power will decrease with square of the distance from the receiver.

In optical fibers, loss of signal power increases linearly with distance.

ii) Frequency Selectivity:

Many media will conduct well relatively over a small range of frequencies. Even within the transmission band of a medium, variation occurs between transmission of various frequencies. This variation is called frequency selectivity.

iii) Time-varying: Their characteristics vary with time

Eg. Mobile radio channels. When the transmitter or receiver moves, the channel changes and affects performance. Eg: Fading and shadowing

v) Non-linearity: Amplifiers/repeaters account for non-linear operation of the channel.

(10)

vi) Shared usage

Communication channels may be efficiently used by different users by multiplexing schemes. It leads to potential interference between different users. It can be avoided by providing perfect isolation between users.

vii) Noise:

The common source of noise is the random motion of electrons in receiver circuits. It provides a fundamental limit to performance.

ELECTROMAGNETIC SPECTRUM

It is the range of all types of EM radiation.

Radiation:

It is the energy that travels and spreads out as it goes. → visible light coming from a lamp.

→ radio waves coming from a radio station.

Other types of EM radiation are → Microwaves

→ infrared

→ ultraviolet light

→ x-rays

→ gamma-rays.

Radio:

It captures radio waves emitted by radio stations bringing favourite tunes. Radio waves are also emitted by stars.

(1)

Microwave:

This type of radiation is also used for cooking. It is also used by the astronomers to study the structure of nearby galaxies.

Infrared:

It is also emitted by our skin, and objects with heat. This light will map the dust between the stars.

Visible: Eyes can detect visible light. Eg: Fireflies, light bulbs, stars will emit visible light.

Ultraviolet: It is emitted by the sun. Hence due to it, skin tans and burns. Hot objects in space will also emit UV radiation.

X-ray:

Dentist use x-rays to image teeth and airport security uses it to see through the bag. Hot gases in the universe also emit x-rays.

Gamma ray:

Doctors use this ray to see inside our body by imaging. Universe is the biggest gamma ray generator.

Measuring Electromagnetic radiation

It is expressed in terms of

- (i) Energy (eV) Electron volts
- (ii) Wavelength (m) metres
- (iii) Frequency (Hz) cycles per second.

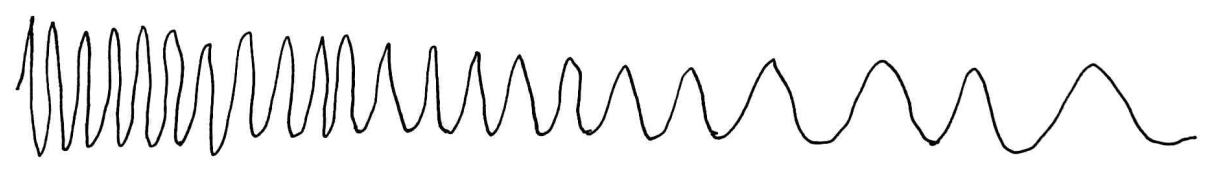
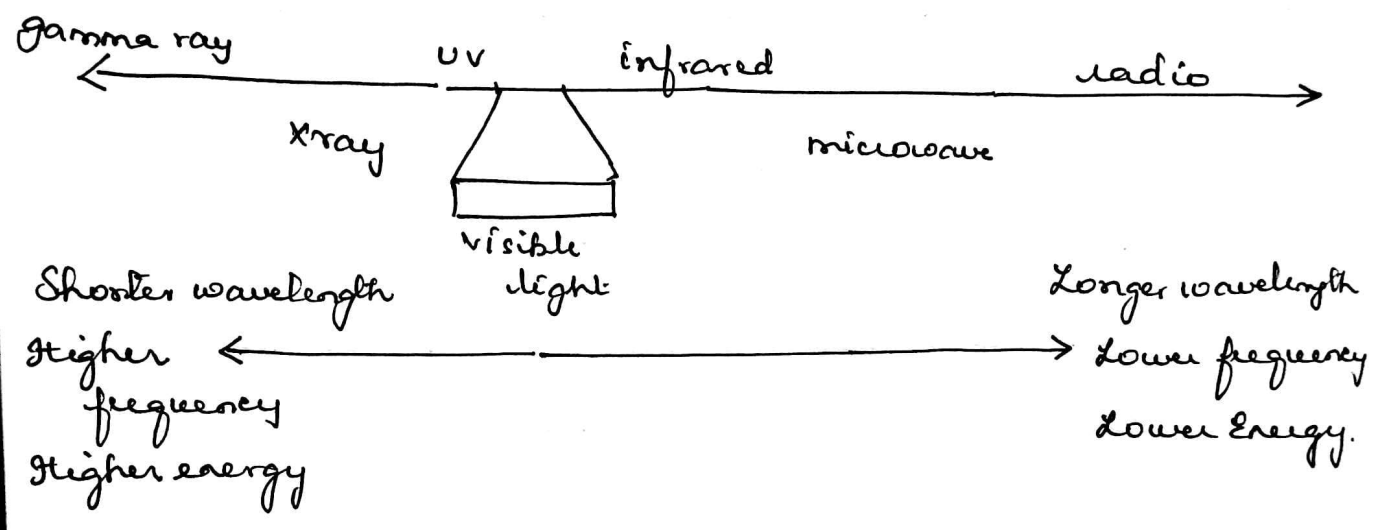

Relationship between E, λ & f

$$f = \frac{c}{\lambda} \quad , \quad f = \frac{E}{h} \quad , \quad E = \frac{hc}{\lambda}$$

c = velocity of light = 3×10^8 m/s.

h = 6.626×10^{-34} J.s planck's constant.

Type	class		frequency
Ionising radiation	γ	Gamma rays	300 EHz
	HX	Hard x-rays	30 EHz
	SX	Soft x-rays	$3 \text{ EHz} - 300 \text{ PHz}$
	EUV	Extreme ultra violet	$30 \text{ PHz} - 3 \text{ PHz}$
visible radiation	NUV	Near ultra violet	$3 \text{ PHz} - 300 \text{ THz}$
	NIR	Near Infrared	$30 \text{ THz} - 3 \text{ THz}$
	MIR	Mid Infrared	3 THz
	FIR	Far Infrared	300 GHz
microwaves & Radio waves	EHF	Extremely High frequency	30 GHz
	SHF	Super High frequency	3 GHz
	UHF	Ultra High frequency	300 MHz
	VHF	Very High frequency	30 MHz
	HF	High frequency	3 MHz
	MF	Medium frequency	300 kHz
	LF	Low frequency	30 kHz
	VLF	Very low frequency	3 kHz

(14)

ULF Ultra low frequency 300 Hz

SLF Super low frequency 30 Hz

ELF Extremely low frequency 3 Hz

Radio frequency Spectrum (RF)

It is defined as the broader part of EM spectrum which is used for electronic communications.

S. No.	Frequency range	Designation	Abbreviation
1.	30 - 300 Hz	Extremely low frequency	ELF
2.	300 Hz - 3 kHz	Voice frequency	VF
3.	3 kHz - 30 kHz	Very low frequency	VLF
4.	30 kHz - 300 kHz	Low frequency	LF
5.	300 kHz - 3 MHz	Medium frequency	MF
6.	3 MHz - 30 MHz	High frequency	HF
7.	30 MHz - 300 MHz	Very High frequency	VHF
8.	300 MHz - 3 GHz	Ultra High frequency	UHF
9.	3 GHz - 30 GHz	Super High frequency	SHF
10.	30 GHz - 300 GHz	Extra High frequency	EHF

FREQUENCY MIXING

- * It is a non-linear electrical circuit.
- * It has two inputs and ~~two~~ ^{an} output signal
- * It produces new signals at the sum and difference of the original frequencies.
- * Mixers are widely used to shift signals from one frequency range to another by a process called Heterodyning.

Types of Mixers: (Based on topology)

i) Unbalanced Mixer: It produces a product signal at the output allowing both the input signals to appear as components in the output.

ii) Single balanced mixer:

One of the input signal is suppressed at the output

iii) Double balanced mixer: Neither of the input signal appears at the output, but only the product signal appears at the output.

Characteristics of a Mixer:

It produces a component at the output which is essentially the product of the two input signals.

(16)

A device that has a non-linear (exponential) characteristic can act as a mixer.

i) passive Mixer:

The desired output signal is always of lower power than the input signals.

ii) Active mixers:

It uses an amplifying device (transistor) to increase the strength of the product signal.

Application of frequency mixer:

It is used in superhetrodyne receiver to move received signals to a common intermediate frequency. It is also used to modulate a carrier signal in radio transmitters.

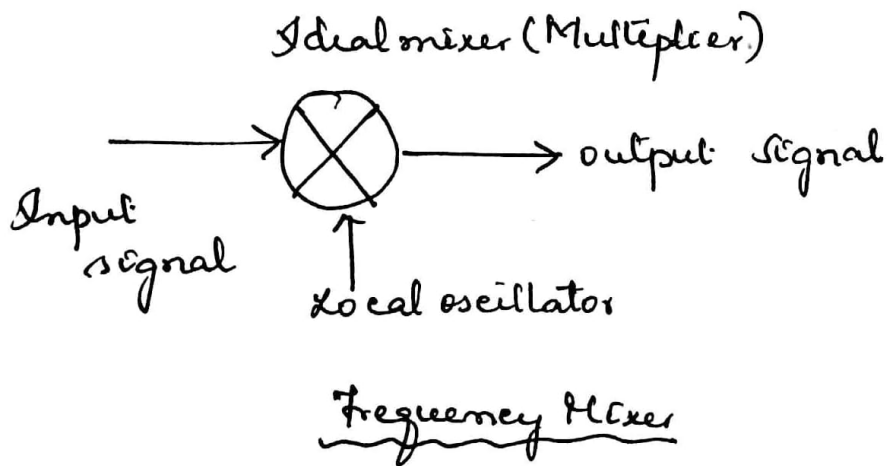

NEED FOR MODULATIONModulation:

It is the process of placing the message signal over some carrier signal to make it suitable for transmission over long distance.

It is the process by which some characteristic of the carrier signal is varied in accordance with the instantaneous value of the message signal.

Modulating signal: Information bearing signal / message signal.

Modulated signal: Signal resulting from the output of the modulation process.

Types of Modulation:Continuous Wave modulation:

Carrier wave is continuous in nature

Eg: (i) Amplitude modulation

(ii) Angle modulation.

Pulse modulation:

Carrier wave is pulse type in nature.

Eg: (i) pulse amplitude modulation (PAM)

(ii) Pulse width modulation (PWM)

(iii) Pulse code modulation (PCM).

Need for modulation

At the transmitter,

- * message signal modulates a high frequency carrier signal
- * Modulated signal is transmitted thro antenna
- * Antenna is located at the top of the transmitter.

channel

modulated signal is travelled down the channel to reach the input of the receiver

Q) Practicality of Antenna:

For efficient radiation and reception, the transmitting and receiving antennas must have lengths comparable to $\lambda/4$ of frequency used.

Ex: AM Broadcast System

Max. Audio frequency = 5 kHz.

Without modulation

$$\text{Height of the antenna } l = \frac{\lambda}{4} = \frac{c}{4f}$$

$$l = \frac{3 \times 10^8}{4 \times 5 \times 10^3} = 5 \text{ km}$$

$$l = 5 \text{ km}$$

It is totally impractical to construct and install an antenna of such a height. Hence it can be reduced by the process of modulation.

(19)

With modulation

$$\text{Carrier frequency} = 4 \text{ MHz}$$

$$l = \frac{\lambda}{4} = \frac{c}{4f} = \frac{3 \times 10^8}{4 \times 4 \times 10^6}$$

$$l = 0.25 \times 100$$

$$l = 25 \text{ m}$$

This antenna height can be achieved practically.

ii) To remove interference :-

Interference occur between stations, if the transmission is done without modulation. Hence it is necessary to translate or shift them in different portion of the electromagnetic spectrum.

iii) Reduction of noise :

With several types of modulation techniques effect of noise can be eliminated.

Demodulation :

The receiver receives the modulated signal. At the receiver, the modulated signal must undergo a reverse process called demodulation to reconstruct the original signal.

Hence it is a process of separating the message signal from the modulated signal.

Baseband Transmission:

- * Baseband signal is the message signal generated from the information source.
- * If the baseband signal is transmitted directly, then it is called baseband transmission.
- * It requires no modulators and demodulators.
- * Baseband signal may be analog or digital.
- * This transmission is preferred at low frequencies.
- * The main drawback is Intersymbol Interference (ISI).

Passband Transmission:

- * Modulated signal is transmitted over the channel.
- * Modulated signal has fixed band of frequencies around carrier frequency. It is of bandpass type.
- * Hence it is called bandpass or passband transmission.
- * This transmission is used at high frequencies.
- * It can be of analog or digital.

(21)

AMPLITUDE MODULATION

The amplitude of the sinusoidal carrier wave is varied in accordance with the baseband signal.

Let $c(t) \Rightarrow$ sinusoidal carrier wave.

$c(t)$ is given as

$$c(t) = A \cos \omega_c t \quad \text{--- (1)}$$

$A \Rightarrow$ maximum Amplitude of the carrier wave

$\omega_c \Rightarrow$ carrier frequency.

Let $x(t) \Rightarrow$ modulating (baseband) signal.

Eqn. for Amplitude modulated wave is given by

$$s(t) = x(t) \cos \omega_c t + A \cos \omega_c t \quad \text{--- (2)}$$

$$s(t) = [A + x(t)] \cos \omega_c t \quad \text{--- (3)}$$

$s(t) \rightarrow$ AM wave.

$$s(t) = E \cos \omega_c t$$

where $E(t) = A + x(t)$

$E(t) =$ Envelope of AM wave.

Hence the modulating signal can be recovered from AM wave by detecting the envelope.

In Amplitude modulation, the maximum Amplitude 'A' of the carrier is made proportional to the instantaneous amplitude of the modulating signal $x(t)$.

(22)

Illustration of AM - Waveforms :-

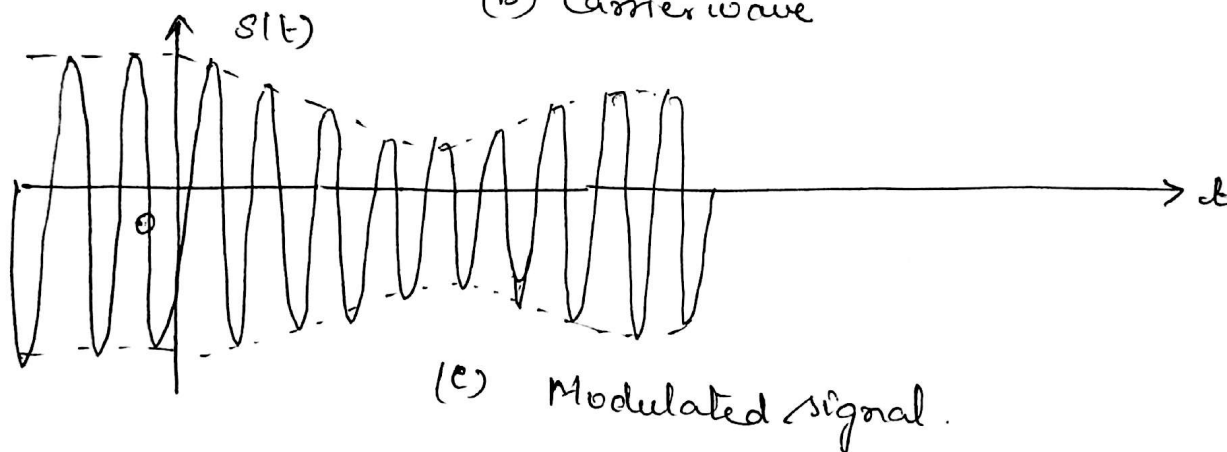
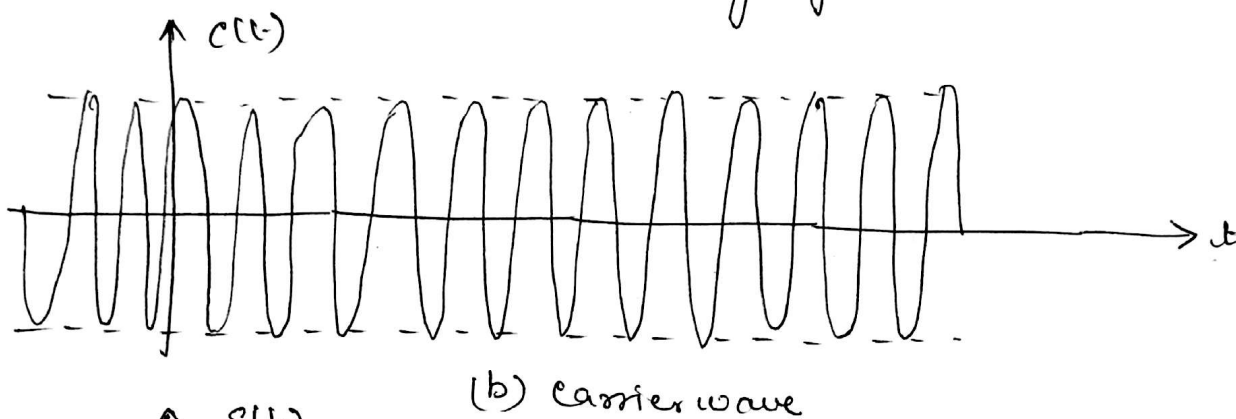
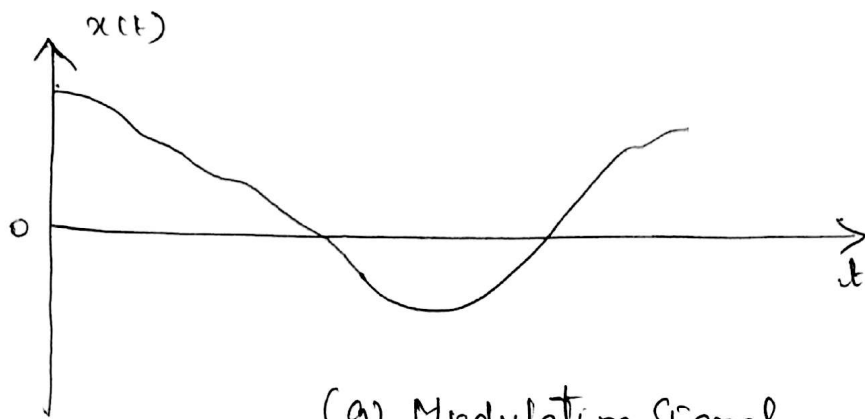

Note ;

* $c(t) = A \cos \omega_c t$

Carrier wave has a fixed frequency ω_c .

* Modulating signal $x(t)$ has the information to be transmitted.

* In AM, this information is superimposed upon the carrier in the form of amplitude variations of the signal.

(23)

- * The resulting signal from AM is called amplitude modulated wave (AM wave)
- * AM wave $s(t)$ has an amplitude $[A + x(t)]$ and constant frequency ω_c .
- * Hence the modulation process results in variation of amplitude A in accordance with $x(t)$ but the frequency remains unchanged.
- * AM wave has a time-varying amplitude called Envelope of AM wave. Envelope of AM wave has the same shape as the message signal or baseband signal.

Spectrum of AM wave (Frequency domain Representation)

$$c(t) = A \cos \omega_c t \quad \text{--- (1)} \quad \cdot \quad x(t) \cos \omega_c t \rightarrow \text{Message Signal.}$$

Eqn for AM wave

$$s(t) = x(t) \cos \omega_c t + A \cos \omega_c t \quad \text{--- (3)}$$

Eqn represents AM wave in time domain.

For spectrum (freq. domain representation), Fourier transform representation is needed.

Let $S(\omega) \Rightarrow$ Fourier-Transform of $s(t)$

$$C(\omega) \Rightarrow \text{F.T } \{ c(t) \}$$

$$X(\omega) \Rightarrow \text{F.T } \{ x(t) \}$$

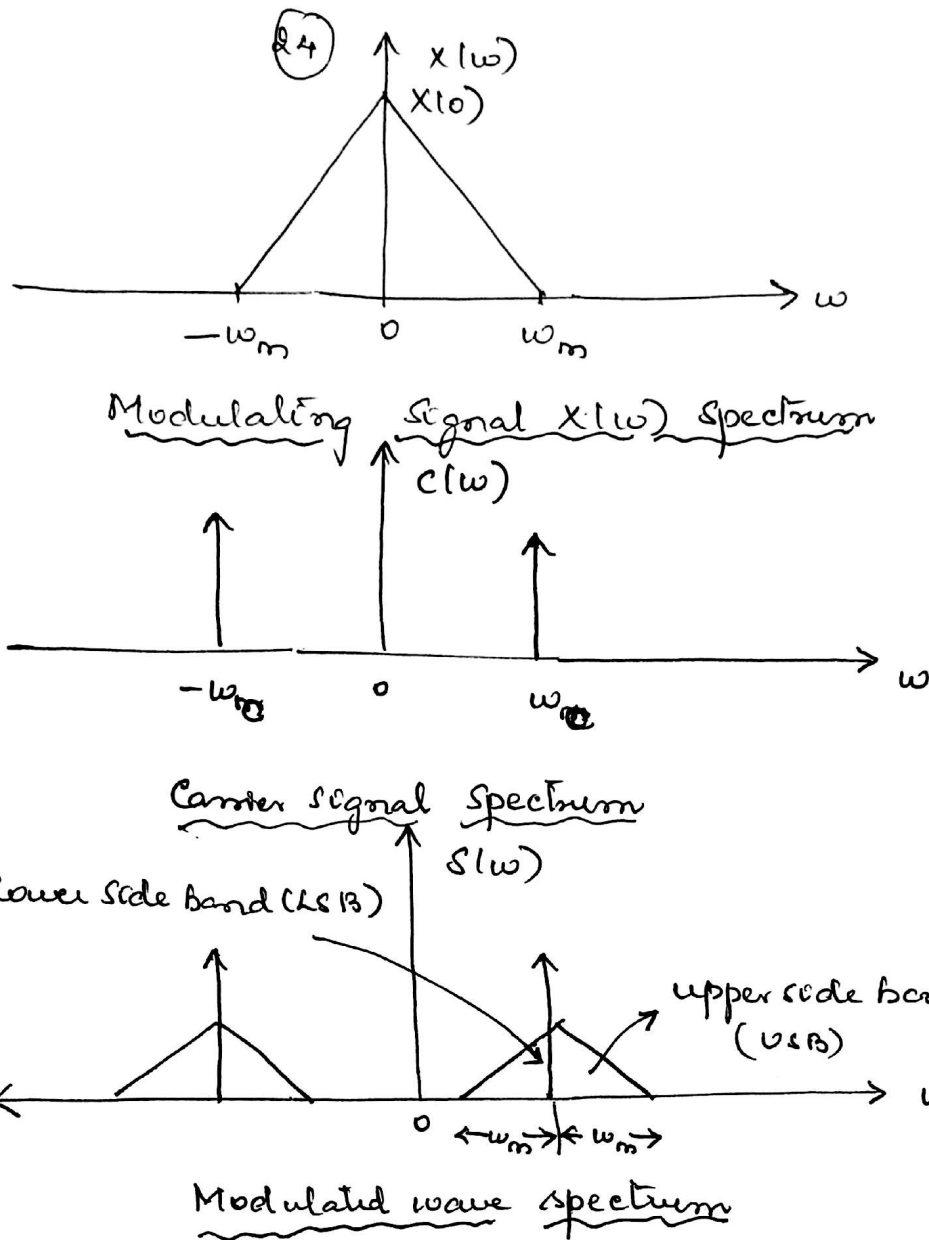

(i) $x(t)$ - spectrum of $x(t)$ → Baseband signal

- * Frequency range $-\omega_m$ to ω_m
- * There is no negative frequency.
- * $-\omega_m$ to zero included for mathematical convenience
- * Bandwidth = ω_m .
- * F.T $\{x(t) \cos \omega_c t\}$ shifts the spectrum of ~~$x(t)$~~ $x(t)$ in frequency domain by an amount ω_c .

To find Fourier transform of $\cos \omega_c t$

$$\cos \omega_c t \longleftrightarrow \pi [\delta(\omega + \omega_c) + \delta(\omega - \omega_c)] \quad \text{--- (1)}$$

(25)

It contains two impulses at ω_c and $-\omega_c$.

To find Fourier Transform of $x(t) \cos \omega_c t$

By frequency shifting theorem

$$\left. \begin{aligned} x(t) &\longleftrightarrow X(\omega) \\ e^{j\omega_c t} x(t) &\longleftrightarrow X(\omega - \omega_c) \end{aligned} \right\} \text{--- (5)}$$

$$e^{-j\omega_c t} x(t) \longleftrightarrow X(\omega + \omega_c) \text{--- (6)}$$

Spectrum of a signal $x(t)$ is shifted by an amount ω_c .

$$\therefore x(t) \cos \omega_c t = x(t) \left[\frac{e^{j\omega_c t} + e^{-j\omega_c t}}{2} \right] \text{--- (7)}$$

$$x(t) \cos \omega_c t = \frac{1}{2} x(t) e^{j\omega_c t} + \frac{1}{2} x(t) e^{-j\omega_c t}$$

$$\therefore \mathcal{F}\{x(t) \cos \omega_c t\} = \frac{1}{2} [X(\omega - \omega_c) + X(\omega + \omega_c)] \text{--- (8)}$$

By Eqs (5) and (6)

Hence multiplication of a signal $x(t)$ by a sinusoid of frequency ω_c shifts the spectrum $X(\omega)$ by $\pm \omega_c$.

To find Fourier Transform of $A \cos \omega_c t$

$$A \cos \omega_c t \longleftrightarrow \pi A [\delta(\omega + \omega_c) + \delta(\omega - \omega_c)] \text{--- (9)}$$

By Egn. (5)

(ii) Spectrum of carrier wave $C(\omega)$

* It the spectrum of carrier signal $x(t) = A \cos \omega_c t$ shifted by $\pm \omega_c$. It consists of two impulses centered at $\pm \omega_c$.

(2b)

(ii) Spectrum of modulated signal $s(t)$ [$S(\omega)$]:-

$$s(t) = A \cos \omega_c t + x(t) \cos \omega_c t$$

$$\therefore S(\omega) = \frac{1}{2} [X(\omega - \omega_c) + X(\omega + \omega_c)] + \pi A [\delta(\omega + \omega_c) + \delta(\omega - \omega_c)]$$

It consists of two factors :-

— (10)

(i) $\frac{1}{2} [X(\omega - \omega_c) + X(\omega + \omega_c)] \Rightarrow$ represents the spectrum of original or baseband signal shifted by $\pm \omega_c$

(ii) $\pi A [\delta(\omega + \omega_c) + \delta(\omega - \omega_c)] \Rightarrow$ represents the presence of carrier signal.

Note:

1) Upper Side band (USB):

This is the band of spectrum of AM wave lying above the carrier frequency ω_c .

2) Lower Side band (LSB):

This is the band lying below the carrier frequency ω_c

* Generally $\omega_c > \omega_m$. so that the sidebands don't overlap each other.

* Highest frequency component = $\omega_c + \omega_m$

Lowest frequency component = $\omega_c - \omega_m$.

\therefore Bandwidth of AM wave = $(\omega_c + \omega_m) - (\omega_c - \omega_m)$

$$B = 2\omega_m$$

Bandwidth:

Bandwidth of AM wave is equal to twice the highest frequency component of modulating signal.

Important definition of AM:Modulation Index:

It is defined as the measure of extent of amplitude variation about an unmodulated maximum carrier. It is represented as m_a .

$$\text{Modulation Index } m_a = \frac{|x(t)|_{\max}}{\text{maximum carrier amplitude.}}$$

$$m_a = \frac{|x(t)|_{\max}}{A}$$

$x(t)_{\max} \rightarrow$ Maximum amplitude of $x(t)$

$A \rightarrow$ maximum amplitude of carrier $c(t)$.

It is also called depth of modulation, degree of modulation or modulation factor.

Percentage modulation:

Absolute value of m_a multiplied by 100.

Overmodulation:

The AM signal with $m_a > 1$ or $m_a > 100\%$ is called overmodulated signal.

Envelope distortion:

$$|x(t)|_{max} \leq A$$

modulating signal $x(t)$ will be preserved in the envelope of the AM signal. if and only if the above condition is satisfied.

If $|x(t)|_{max} > A$, then $m_a > 1$ or the % of modulation is greater than 100, the baseband signal is not preserved in the envelope. Hence the baseband signal will be distorted. This is called Envelope distortion

Two cases of modulation (i) $m_a < 1$

$$|x(t)|_{max} < A$$

Baseband signal can be fully recovered from the envelope of AM wave.

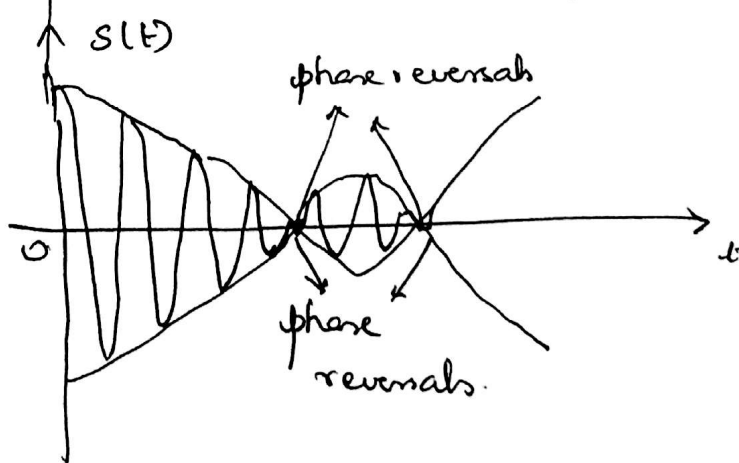
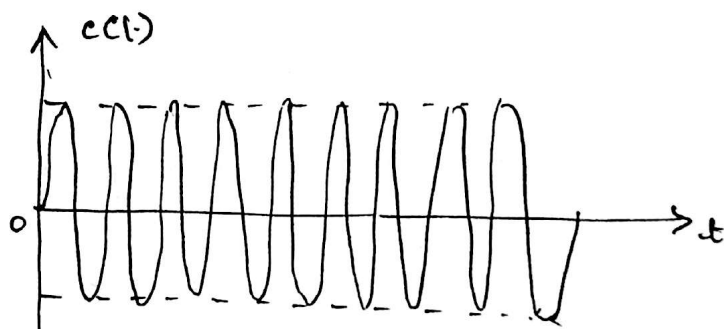
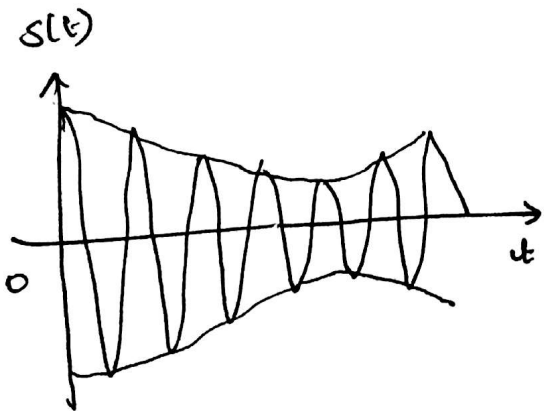
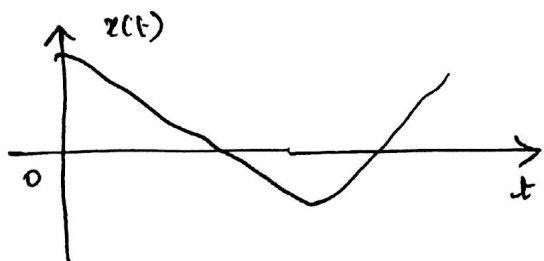

(ii) $m_a > 1$

$$|x(t)|_{max} > A, m_a > 1$$

over modulation occurs.

Single Tone Amplitude Modulation (AM) - X.

- * Base band signal consists of large no. of frequency components.
- * Carrier signal is a fixed frequency signal.
- * Hence In AM, a carrier signal is modulated by a large no. of frequency components.

In Single tone modulation, baseband signal is assumed to be single frequency signal. Modulation is done by single frequency or tone. This is called Single tone amplitude modulation.

Mathematical representation

$$\text{Single tone modulating signal } x(t) = V_m \cos \omega_m t \quad \text{--- (1)}$$

$V_m \rightarrow$ maximum amplitude of $x(t)$

$\omega_m \rightarrow$ maximum (single) frequency of $x(t)$

$$\text{Carrier signal } c(t) = A \cos \omega_c t \quad \text{--- (2)}$$

Now AM signal will be

$$s(t) = [A + x(t)] \cos \omega_c t$$

$$s(t) = A \cos \omega_c t + x(t) \cos \omega_c t \quad \text{--- (3)}$$

Substituting $x(t)$ in (3).

$$s(t) = A \cos \omega_c t + V_m \cos \omega_m t \cos \omega_c t \quad \text{--- (4)}$$

$$s(t) = A \cos \omega_c t \left[1 + \frac{V_m}{A} \cos \omega_m t \right] \quad \text{--- (5)}$$

For AM, modulation index $m_a = \frac{|x(t)|_{\max}}{A}$

$$|x(t)|_{\max} = V_m$$

$$\therefore \boxed{m_a = \frac{V_m}{A}} \quad \text{--- (6)}$$

(30)

putting the value of $\frac{V_m}{A}$ in (5)

$$s(t) = A \cos \omega_c t [1 + m_a \cos \omega_m t] \quad \text{--- (7)}$$

This is the desired expression for single tone modulating signal

Simplified Expression:

$$s(t) = A \cos \omega_c t + A \cdot m_a \cos \omega_m t \cos \omega_c t$$

$$= A \cos \omega_c t + \frac{A \cdot m_a}{2} [2 \cos \omega_c t \cos \omega_m t]$$

$$s(t) = A \cos \omega_c t + \frac{A \cdot m_a}{2} [\cos(\omega_c + \omega_m)t + \cos(\omega_c - \omega_m)t]$$

$$s(t) = A \cos \omega_c t + \frac{A \cdot m_a}{2} \cos(\omega_c + \omega_m)t + \frac{A \cdot m_a}{2} \cos(\omega_c - \omega_m)t$$

AM signal has three frequency components

- i) Carrier frequency ω_c with amplitude A .
- ii) upper sideband $(\omega_c + \omega_m)$ with amplitude $\frac{m_a \cdot A}{2}$
- iii) Lower sideband $(\omega_c - \omega_m)$ with amplitude $\frac{m_a \cdot A}{2}$.

Single sided frequency spectrum of single tone AM wave

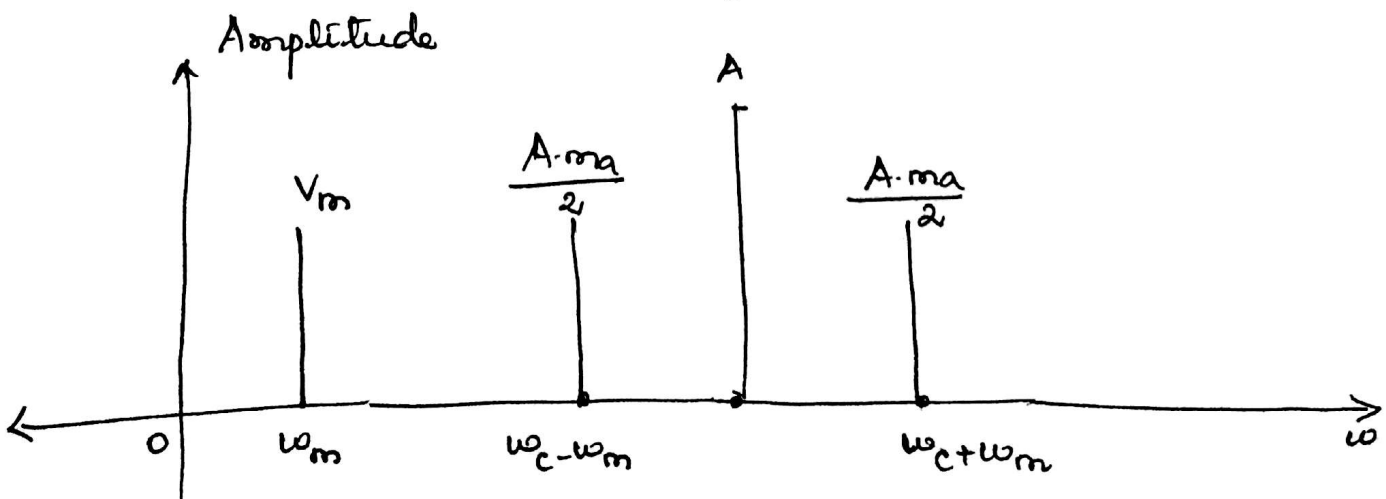

(31)

Power content in AM wave

General expression for AM wave

$$s(t) = A \cos \omega_c t + x(t) \cos \omega_c t \quad \text{--- (1)}$$

Total power $P =$ Carrier power P_c + Sideband power P_s --- (2)

Carrier power (P_c):

It is equal to the mean square (ms) value of the carrier wave $A \cos \omega_c t$

$P_c =$ mean square value of $A \cos \omega_c t$

$$P_c = [A \cos \omega_c t]^2$$
$$= \frac{1}{2\pi} \int_0^{2\pi} A^2 \cos^2 \omega_c t \, dt$$

After integration,

$$P_c = \frac{A^2}{2} \quad \text{--- (3)}$$

Sideband power (P_s):

It is equal to the mean square value of the sideband term $x(t) \cos \omega_c t$

$P_s =$ mean square value of $x(t) \cos \omega_c t$

$$P_s = [x(t) \cos \omega_c t]^2 \quad \text{--- (4)}$$

$$= \frac{1}{2\pi} \int_0^{2\pi} x^2(t) \cos^2 \omega_c t \, dt$$

$$\left[\cos^2 \theta = \frac{1 + \cos 2\theta}{2} \right]$$

$$P_s = \frac{1}{2\pi} \left[\frac{1}{2} \int_0^{2\pi} x^2(t) \, dt + \int_0^{2\pi} x^2(t) \cos 2\omega_c t \, dt \right] \quad \text{--- (5)}$$

In AM generation, BPF (tuned circuit) is used to eliminate the second term ($2\omega_c$).

$$\therefore P_c = \frac{1}{2\pi} \int_0^{2\pi} \frac{1}{2} x^2(t) dt$$

$$P_c = \frac{1}{2} \overline{x^2(t)} \quad \text{--- (6)}$$

Sideband power is due to the equal contribution from upper and lower sideband.

$$\therefore P_{S(LSB)} = P_{S(USB)} = \frac{P_s}{2} = \frac{1}{4} \overline{x^2(t)} \quad \text{--- (7)}$$

$$\therefore \text{Total power } P_t = P_c + P_s$$

$$= \frac{A^2}{2} + \frac{\overline{x^2(t)}}{2}$$

$$P_t = \frac{1}{2} \left[A^2 + \overline{x^2(t)} \right] \quad \text{--- (8)}$$

Transmission Efficiency of AM Signal

$$P_t = P_c + P_s$$

$P_c \rightarrow$ Carrier power takes the large percentage of total transmitted power. But it takes no information or message. Hence useful message power is contained only in P_s .

Transmission efficiency (η) is defined as the percentage of total power contributed by the sidebands.

$$\therefore \eta = \frac{P_s}{P_t} \times 100$$

(32)

$$P_s = \frac{1}{2} \overline{x^2(t)}$$

$$P_t = \frac{1}{2} A^2 + \frac{1}{2} \overline{x^2(t)}$$

$$\therefore \eta = \frac{\frac{1}{2} \overline{x^2(t)}}{\frac{1}{2} A^2 + \frac{1}{2} \overline{x^2(t)}} \times 100$$

$$\boxed{\eta = \frac{100 \overline{x^2(t)}}{A^2 + \overline{x^2(t)}}$$

Maximum η is 33.33% for AM wave. Only one third of the total power is carried by the sidebands and rest two third is wasted

Power of single tone AM signal - X.

$$x(t) = V_m \cos \omega_m t$$

$$c(t) = A \cos \omega_c t$$

$$\text{Carrier power } P_c = \overline{(A \cos \omega_c t)^2} = \frac{A^2}{2}$$

$$\text{Sideband power } P_s = \frac{1}{2} \overline{x^2(t)}$$

$$P_s = \frac{1}{2} \overline{(V_m \cos \omega_m t)^2}$$

$$P_s = \frac{1}{2} \frac{V_m^2}{2} = \frac{V_m^2}{4}$$

$$\text{Total modulated power } P_t = P_s + P_c$$

$$= \frac{V_m^2}{4} + \frac{A^2}{2}$$

$$P_t = \frac{A^2}{2} \left[1 + \frac{1}{2} \left(\frac{V_m^2}{A^2} \right) \right]$$

(33)

$$P_t = \frac{A^2}{2} \left[1 + \frac{1}{2} \left(\frac{V_m}{A} \right)^2 \right]$$

$$\frac{V_m}{A} = \frac{\text{maximum baseband amplitude}}{\text{maximum carrier amplitude}} = m_a$$

$$\therefore P_t = \frac{A^2}{2} \left[1 + \frac{1}{2} m_a^2 \right]$$

$$\text{But } P_c = \frac{A^2}{2}$$

$$\therefore \boxed{P_t = P_c \left[1 + \frac{m_a^2}{2} \right]} \quad \cdot X.$$

Current calculation for single tone AM:

$$P_t = P_c \left[1 + \frac{m_a^2}{2} \right]$$

$$\frac{P_t}{P_c} = 1 + \frac{m_a^2}{2}$$

$$P_t = I_t^2 R \quad ; \quad P_c = I_c^2 R$$

$$\therefore \frac{I_t^2 R}{I_c^2 R} = 1 + \frac{m_a^2}{2}$$

$$\frac{I_t^2}{I_c^2} = 1 + \frac{m_a^2}{2}$$

$$\frac{I_t}{I_c} = \sqrt{1 + \frac{m_a^2}{2}}$$

$$\boxed{I_t = I_c \sqrt{1 + \frac{m_a^2}{2}}} \quad \cdot X.$$

Power content in Multiple-tone AM signal

Multitone amplitude modulation is a type of modulation in which the modulating signal consists of more than one frequency components.

Let

$$\therefore x(t) = V_1 \cos \omega_1 t + V_2 \cos \omega_2 t + V_3 \cos \omega_3 t.$$

$$\text{AM wave } s(t) = [A + x(t)] \cos \omega_c t$$

$$s(t) = [A + V_1 \cos \omega_1 t + V_2 \cos \omega_2 t + V_3 \cos \omega_3 t] \cos \omega_c t$$

$$s(t) = A \left[1 + \frac{V_1}{A} \cos \omega_1 t + \frac{V_2}{A} \cos \omega_2 t + \frac{V_3}{A} \cos \omega_3 t \right] \cos \omega_c t$$

$$\frac{V}{A} = m_a \text{ (modulation index)}$$

$$\text{Let } m_1 = \frac{V_1}{A}, m_2 = \frac{V_2}{A}, m_3 = \frac{V_3}{A} \text{ (modulation indexes)}$$

$$\therefore s(t) = A [1 + m_1 \cos \omega_1 t + m_2 \cos \omega_2 t + m_3 \cos \omega_3 t] \cos \omega_c t$$

$$P_t = \text{Total power} = P_c + P_s = \text{carrier power} + \text{sideband power.}$$

$$P_c = \frac{A^2}{2}$$

$$P_s = \frac{1}{2} \overline{x^2(t)}$$

$$P_s = \frac{1}{2} \left[\overline{(V_1 \cos \omega_1 t)^2} + \overline{(V_2 \cos \omega_2 t)^2} + \overline{(V_3 \cos \omega_3 t)^2} \right]$$

$$V_1 = m_1 A, V_2 = m_2 A, V_3 = m_3 A.$$

$$P_s = \frac{1}{2} \left[\overline{(m_1 A \cos \omega_1 t)^2} + \overline{(m_2 A \cos \omega_2 t)^2} + \overline{(m_3 A \cos \omega_3 t)^2} \right]$$

$$= \frac{1}{2} \left[\frac{m_1^2 A^2}{2} + \frac{m_2^2 A^2}{2} + \frac{m_3^2 A^2}{2} \right]$$

$$P_s = \frac{1}{4} A^2 [m_1^2 + m_2^2 + m_3^2]$$

(35)

∴ Total power $P_t = P_c + P_s$

$$P_t = \frac{A^2}{2} + \frac{1}{A} A^2 [m_1^2 + m_2^2 + m_3^2]$$
$$= \frac{A^2}{2} \left[1 + \frac{1}{2} (m_1^2 + m_2^2 + m_3^2) \right]$$

$$P_t = P_c \left[1 + \frac{m_1^2}{2} + \frac{m_2^2}{2} + \frac{m_3^2}{2} \right]$$

This Expression is extended to n - modulating terms.

$$P_t = P_c \left[1 + \frac{m_1^2}{2} + \frac{m_2^2}{2} + \frac{m_3^2}{2} + \dots + \frac{m_n^2}{2} \right]$$

Total modulation index

For multiple tone modulation, total power is

$$P_t = P_c \left[1 + \frac{m_1^2}{2} + \frac{m_2^2}{2} + \frac{m_3^2}{2} + \dots + \frac{m_n^2}{2} \right] \quad \text{--- (1)}$$

For single tone modulation, total power is

$$P_t = P_c \left[1 + \frac{m_t^2}{2} \right] \quad \text{--- (2)}$$

Comparing (1) and (2)

$$m_t^2 = m_1^2 + m_2^2 + m_3^2 + \dots + m_n^2$$

$$m_t = \sqrt{m_1^2 + m_2^2 + m_3^2 + \dots + m_n^2}$$

This is the desired expression for the total modulation index.

Generation of Amplitude Modulation (AM)

Two methods of AM generation:

i) Low level AM modulation (Low power level)

→ Square law diode modulation

→ Switching modulation

ii) High level AM modulation (High power level)

→ collector modulation

Square law diode Modulation

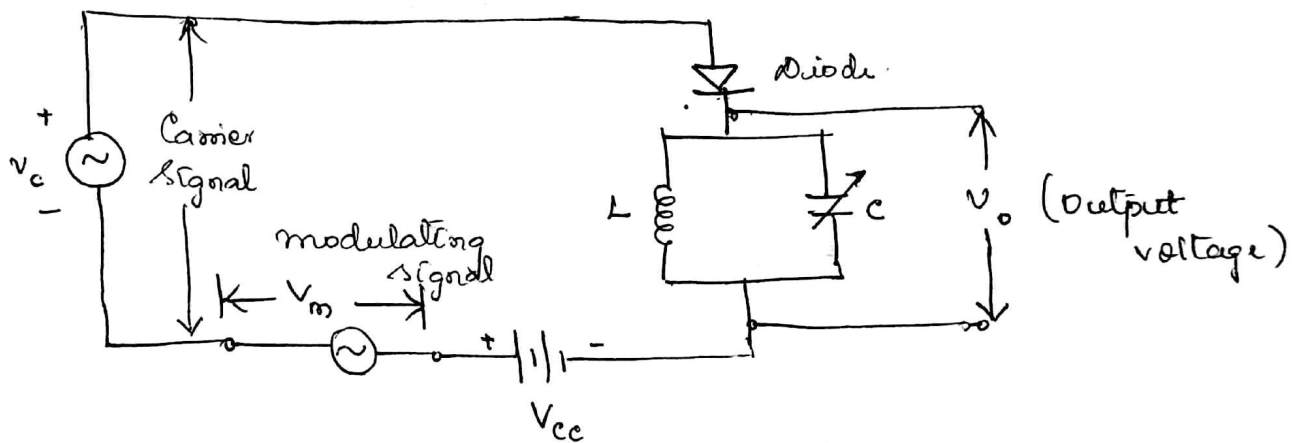

I-v characteristics of diode

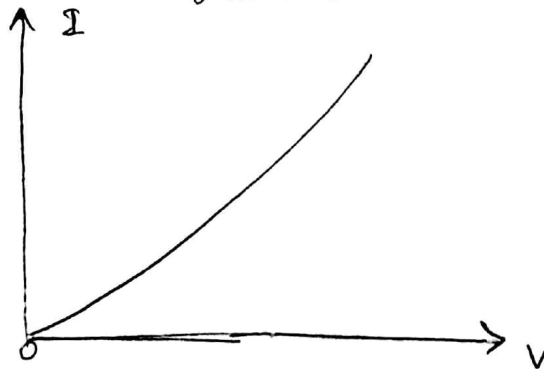

It makes use of non-linear characteristics of diode.

* carrier and modulating signals are applied across the diode.

* d.c battery V_{cc} is connected across the diode to get fixed operating point on the characteristic curve.

Principle:

When carrier and modulating frequencies are applied across the diode, different frequency terms appear at the output of the diode.

If it is applied across the tuned circuit, this tuned circuit is tuned to the carrier frequency. It has a narrow bandwidth which passes only the sidebands and rejects all other frequencies.

At the output, carrier and sidebands are obtained and Amplitude modulated wave is produced.

Mathematical Analysis:-

$$\text{Carrier voltage } v_c = V_c \cos \omega_c t \quad \text{--- (1)}$$

$\omega_c \rightarrow$ carrier frequency

$$\text{modulating voltage } v_m = V_m \cos \omega_m t \quad \text{--- (2)}$$

$\omega_m \rightarrow$ modulating frequency.

\Rightarrow Total a.c voltage across the diode

$$v_s = v_c + v_m$$

$$v_s = V_c \cos \omega_c t + V_m \cos \omega_m t \quad \text{--- (3)}$$

non linear relationship between voltage and current for a diode

is given as

$$i = a + b v_s + c v_s^2 \quad \text{--- (4)}$$

$a, b, c \rightarrow$ constants.

$i \rightarrow$ current thro the diode

$v_s \rightarrow$ voltage across the diode

(38)

putting the value of v_s in eqn i .

$$i = a + b [V_c \cos \omega_c t + V_m \cos \omega_m t] + c [V_c \cos \omega_c t + V_m \cos \omega_m t]^2$$

$$i = a + b V_c \cos \omega_c t + b V_m \cos \omega_m t + c [V_c^2 \cos^2 \omega_c t + V_m^2 \cos^2 \omega_m t + 2V_c V_m \cos \omega_c t \cos \omega_m t]$$

$$i = a + b V_c \cos \omega_c t + b V_m \cos \omega_m t + c V_c^2 \cos^2 \omega_c t + c V_m^2 \cos^2 \omega_m t +$$

$$2c V_m V_c \cos \omega_c t \cos \omega_m t$$

$$i = a + b V_c \cos \omega_c t + b V_m \cos \omega_m t + \frac{1}{2} c V_c^2 (2 \cos^2 \omega_c t) +$$

$$\frac{1}{2} c V_m^2 (2 \cos^2 \omega_m t) +$$

$$c V_m V_c (2 \cos \omega_c t \cos \omega_m t)$$

$$i = a + b V_c \cos \omega_c t + b V_m \cos \omega_m t + \frac{1}{2} c V_c^2 (1 + \cos 2\omega_c t) +$$

$$\frac{1}{2} c V_m^2 (1 + \cos 2\omega_m t) +$$

$$c V_m V_c [\cos (\omega_c + \omega_m)t + \cos (\omega_c - \omega_m)t]$$

$$i = \left[a + \frac{1}{2} c V_c^2 + \frac{1}{2} c V_m^2 \right] + \left[b V_c \cos \omega_c t + b V_m \cos \omega_m t \right]$$

(1)

(2)

(3)

$$+ \frac{1}{2} \left[\frac{1}{2} c V_c^2 \cos 2\omega_c t + \frac{1}{2} c V_m^2 \cos 2\omega_m t \right] + c V_c V_m \cos (\omega_c + \omega_m)t$$

(4)

(5)

$$+ c V_c V_m \cos (\omega_c - \omega_m)t$$

(b)

(39)

Term (1) \Rightarrow dc term

Term (2) \Rightarrow carrier signal

Term (3) \Rightarrow modulating signal.

Term (4) \Rightarrow harmonics of carrier & modulating signal.

Term (5) \Rightarrow upper sideband

Term (6) \Rightarrow lower sideband

Tuned circuit is tuned to carrier frequency ω_c . The frequency components developed in the output are ω_c , $(\omega_c + \omega_m)$ and $(\omega_c - \omega_m)$. The rest of the frequency components are rejected by the tuned circuit.

$$\therefore i_o = bV_c \cos \omega_c t + cV_c V_m \cos(\omega_c + \omega_m)t + eV_c V_m \cos(\omega_c - \omega_m)t$$

$$i_o = bV_c \cos \omega_c t + 2cV_c V_m [\cos(\omega_c + \omega_m)t + \cos(\omega_c - \omega_m)t]$$

$$i_o = bV_c \cos \omega_c t + 2cV_c V_m [\cos \omega_c t \cos \omega_m t]$$

$$i_o = bV_c \cos \omega_c t + 2cV_c V_m \cos \omega_c t \cos \omega_m t$$

$$= bV_c \left[1 + \frac{2cV_m}{b} \cos \omega_m t \right] \cos \omega_c t$$

$$i_o = bV_c (1 + m_a \cos \omega_m t) \cos \omega_c t$$

where $m_a = \frac{2cV_m}{b}$ modulation index.

Collector Modulation Method (Class-C Amplifier)

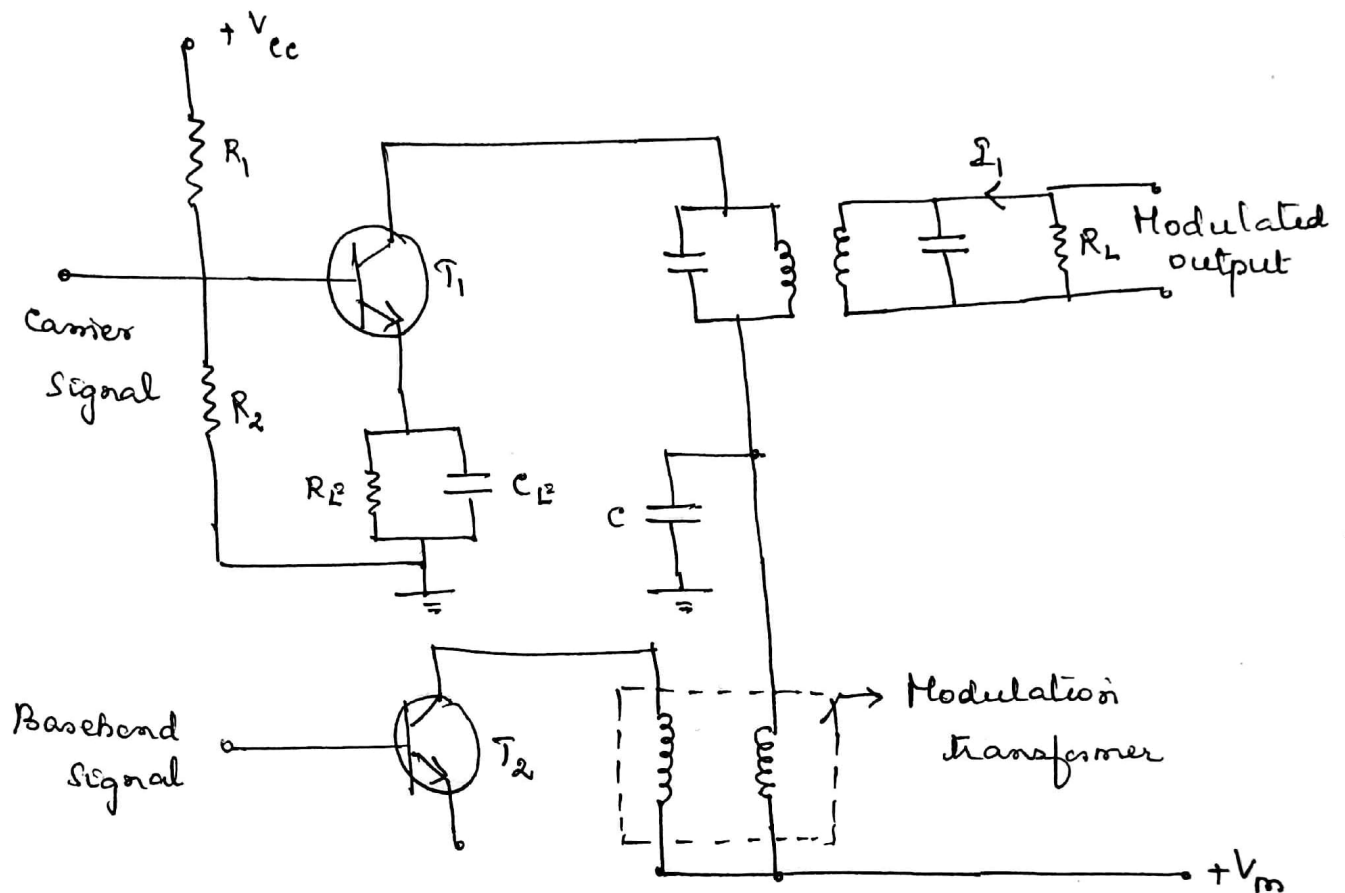

Illustration of collector modulation method

Construction:

- * Transistor T_1 makes a radio frequency (RF) class-C Amplifier.
- * At the base of T_1 , Carrier signal is applied.
- * V_{cc} is the collector supply used for biasing.
- * Transistor T_2 makes class-B amplifier.
- * Class-B amplifier amplifies modulating signal.
- * Modulating signal appears across Modulation Transformer after amplification.
- * Capacitor c offers a low resistance path for high frequency carrier signal.

(41)

* Carrier signal will not flow thro modulation transformer.

Operating principle

$$RI_t \equiv V_c \quad \text{--- (1)}$$

$R \rightarrow$ Resistance of output tank circuit.

$I_t \Rightarrow$ Output tank current.

$V_{cc} \Rightarrow$ collector supply voltage

$V_c \Rightarrow$ Varying value of V_{cc} .

$RI_t \Rightarrow$ Magnitude of output voltage

This is class-C Amplifier, the magnitude of output voltage is always a fraction of supply voltage V_{cc} .

Before applying baseband signal, unmodulated carrier is amplified by class-C modulating amplifier. (T₁) and its magnitude will remain constant at V_{cc} .

If baseband signal is applied $v_m = V_m \cos \omega_m t$ across the modulating transformer, it will get added to V_{cc} . This results in variation in V_{cc} . Slow variation changes the magnitude of carrier signal voltage at the o/p of class-C amplifier.

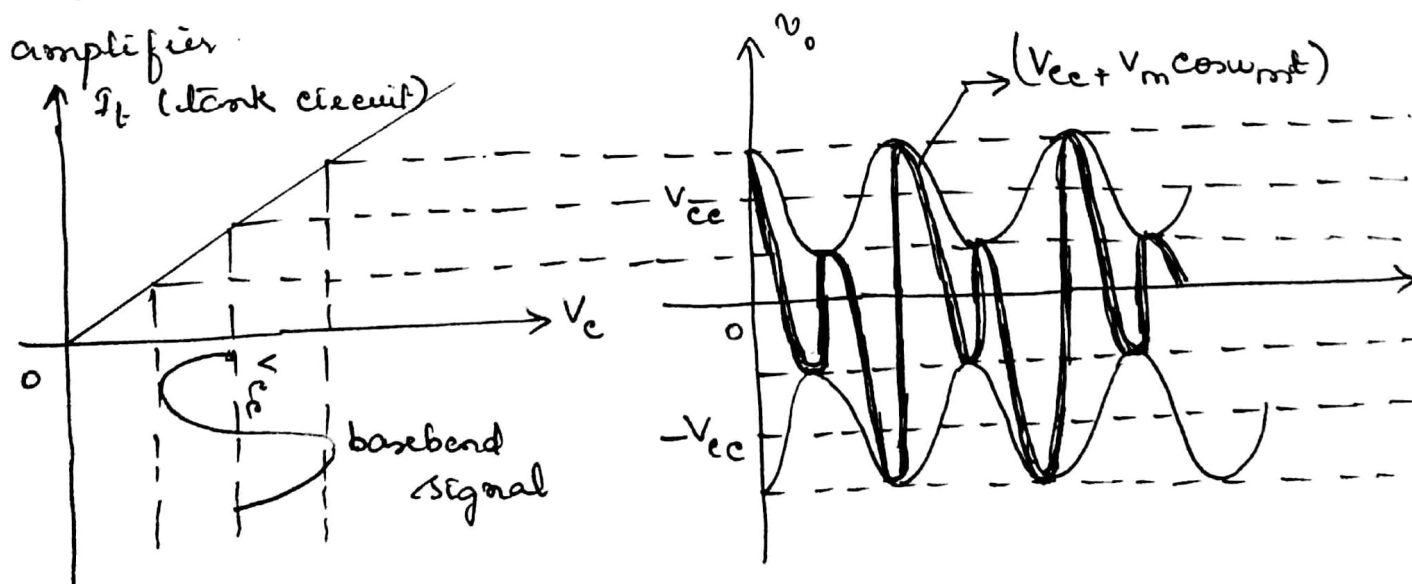

(42)

Mathematical Analysis

slowly varying V_c is given as

$$V_c = V_{cc} + V_m$$

$$V_c = V_{cc} + V_m \cos \omega_m t \quad \text{--- (1)}$$

$$m_a = \frac{\text{maximum modulating voltage}}{\text{maximum carrier voltage}}$$

$$m_a = \frac{V_m}{V_{cc}}$$

$$\therefore V_c = V_{cc} + m_a V_{cc} \cos \omega_m t$$

$$V_c = V_{cc} [1 + m_a \cos \omega_m t] \quad \text{--- (2)}$$

Carrier voltage $v_c = V_{cc} \cos \omega_c t$

modulated o/p voltage $v_o = V_c \cos \omega_c t$

putting value of V_c is v_o

$$v_o = V_{cc} [1 + m_a \cos \omega_m t] \cos \omega_c t$$

This is the required expression for AM wave.

DEMODULATION OF AM WAVE

The process of extracting a modulating or baseband signal from the modulated ~~carrier~~ signal is called demodulation or detection. The devices used for this purpose is called demodulators or detectors. For AM, demodulators used are:

- i) Square law detectors
- ii) Envelope detectors.

Square law detector

- * It is used to demodulate a low level AM signal.
(below 1V)

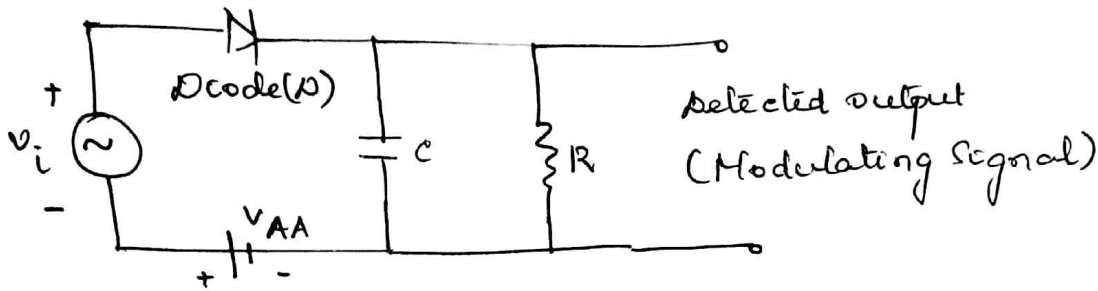

Square law modulator

Square law detector

- * Filter used is a band pass filter
- * Filter used is a low pass filter
- * Since it is low level detection, operating point is restricted to the non-linear portion of V-I characteristics of the device.
- * For this, dc supply voltage V_{AA} is used.
- * Operation is limited to non-linear portion of diode characteristic curve.
- * Lower portion of the waveform is suppressed.

Mathematical Analysis

v → input modulated voltage

AM wave is expressed as

$$v = A(1 + m_a \cos \omega_m t) \cos \omega_c t \quad \text{--- (1)}$$

distorted output diode current is expressed by square law

$$i = av + bv^2 \quad \text{--- (2)}$$

Square law indicates non-linear relationship.

(14)

putting value of θ in Eqn i.

$$-i = a [A(1+m_a \cos \omega_m t) \cos \omega_c t] + b [A(1+m_a \cos \omega_m t) \cos \omega_c t]^2$$

Expansion of the above expression leads to frequencies like $2\omega_c$, $2(\omega_c \pm \omega_m)$, ω_m and $2\omega_m$ along with the input frequency terms.

Hence low pass filter is used to pass frequencies upto ω_m and reject other higher frequency components. Thus the modulating signal can be recovered from the input modulated signal.

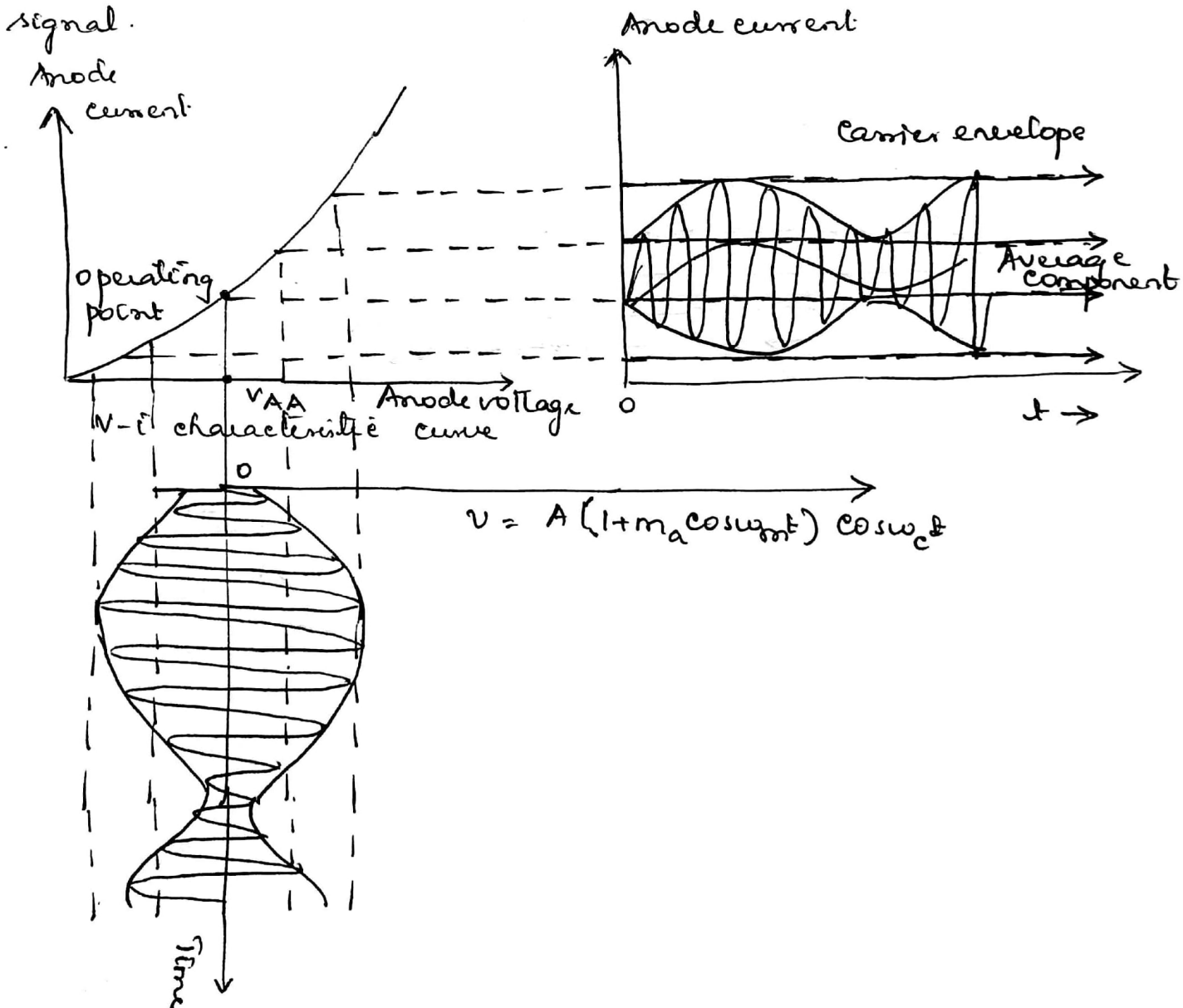

Linear diode or Envelope detector

Diode operating in a linear region of $v-i$ characteristic curve can extract the envelope of an AM wave. This type of detector is called envelope detector or a linear detector

Linear diode detector circuit.

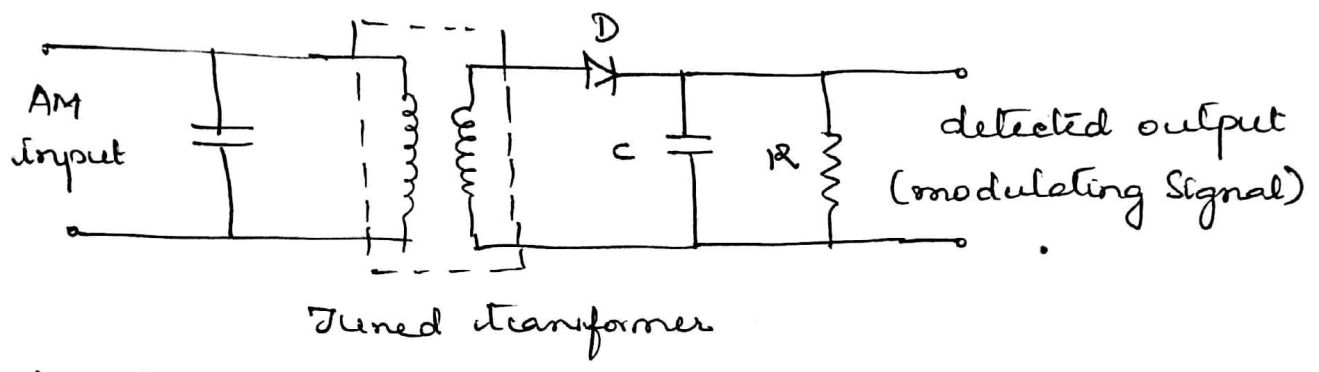

Characteristics of linear diode detector

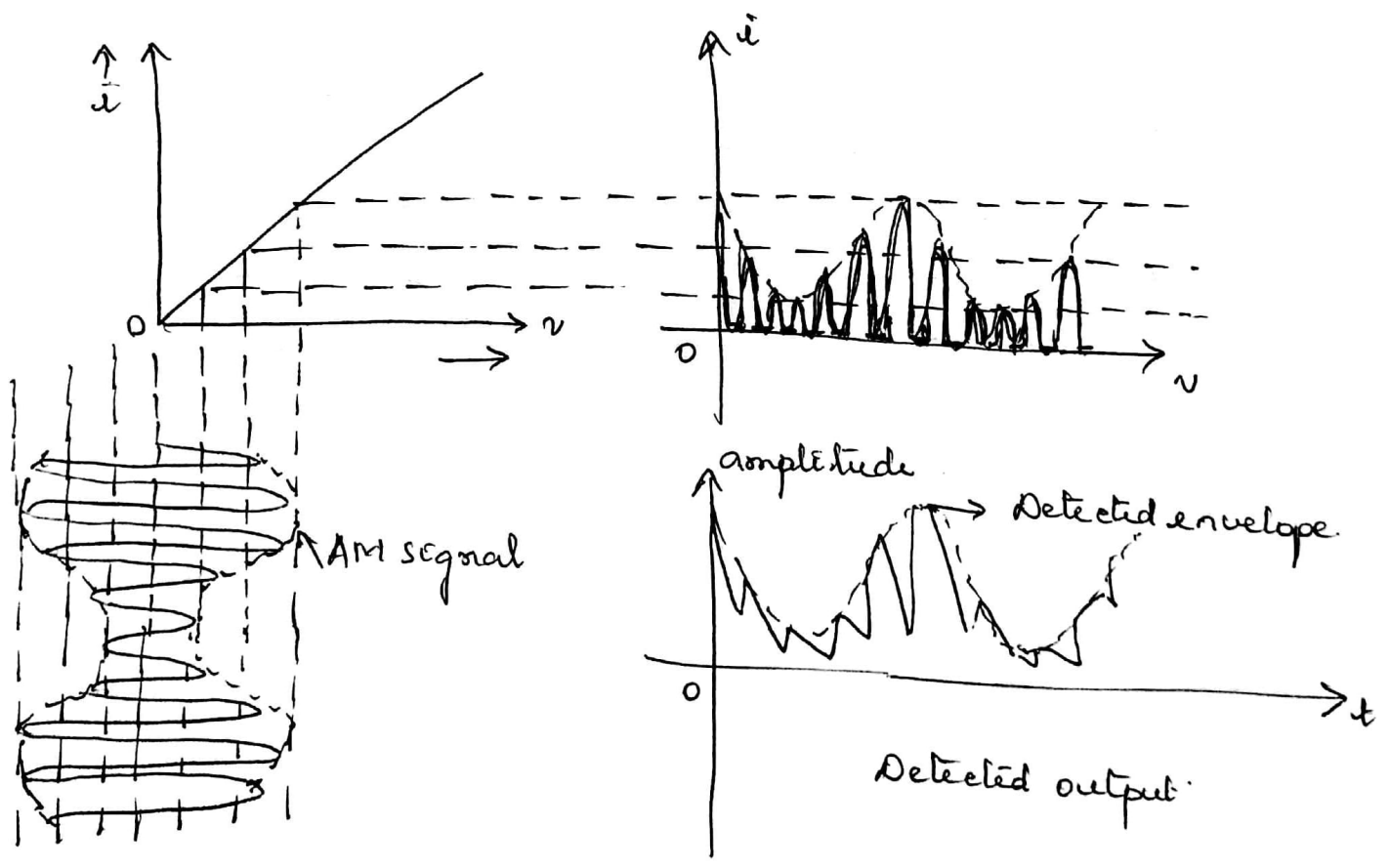

Operating principle:

- * Tuned transformer provides perfect tuning to desired carrier frequency ω_c .
- * RC Network is the time constant network.
- * It demodulates high level signal (amplitude > 1 volt)
- * Operation takes place in the linear portion of V-I curve.

With no capacitor:

- * detector circuit operates as a halfwave rectifier.

With capacitor:

positive Half cycle:

- * diode conducts
- * capacitor is charged to peak value of carrier voltage

Negative Half cycle:

- * diode reverse biased.
- * diode does not conduct.
- * input carrier voltage is disconnected
- * capacitor discharges thro R
- * Time constant $\tau = RC$
- * This process repeats again and again.
- * Op voltage across c is a spiky modulating or baseband signal.
- * This envelope is same as that of carrier signal.
- * Spikes are introduced due to charging and discharging of the capacitor c.

Choice of time constant RC

- (i) Low RC : It results in large fluctuations in the output voltage.
- (ii) Large RC : discharge curve is almost horizontal, and it missed several peaks.

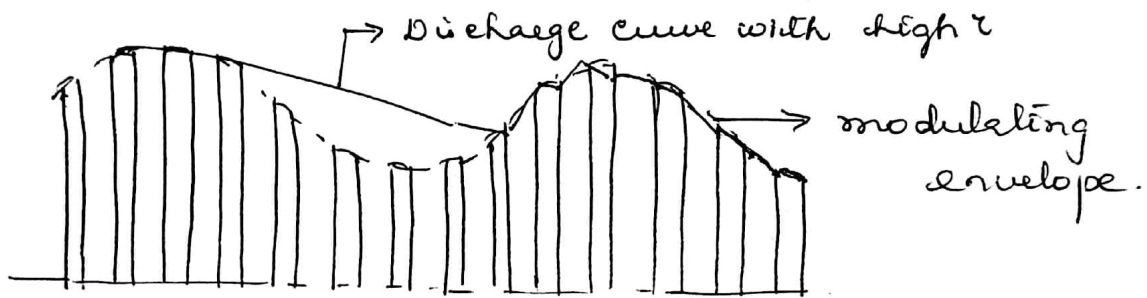

Effect of high RC on the performance of diode detector

- * High RC is desirable to avoid clipping.
- * Maximum allowable value of time constant RC is such that the rate of discharge of C is same as the rate of decrease of modulation envelope.

Mathematical Expression :

$$v = V_c [1 + m_a \cos \omega_m t] \text{ — (1)}$$

$\omega_m \rightarrow$ maximum modulating frequency.

$$\frac{dv}{dt} = -V_c m_a \cdot \omega_m \sin \omega_m t \text{ — (2)}$$

At $t = t_0$, envelope voltage is $v = v_0$.

$$v_0 = V_c [1 + m_a \cos \omega_m t_0] \text{ — (3)}$$

$$\left. \frac{dv}{dt} \right|_{t=t_0} = -\omega_m \cdot m_a V_c \sin \omega_m t_0 \text{ — (4)}$$

(48)

At $t = t_0$, capacitor C starts discharging thro R and is eventually charged to $V_{C0} =$ Envelope voltage

$$V_{C0} = V_0 = V_c [1 + m_a \cos \omega_m t_0] \quad \text{--- (5)}$$

voltage across the capacitor V_c

$$V_c = V_{C0} e^{-(t-t_0)/RC} \quad \text{--- (6)}$$

$$\frac{dV_c}{dt} = \frac{-V_{C0} e^{-(t-t_0)/RC}}{RC} \quad \text{--- (7)}$$

At $t = t_0$,

$$\begin{aligned} \left. \frac{dV_c}{dt} \right|_{t=t_0} &= -\frac{V_{C0}}{RC} e^0 \\ &= -\frac{1}{RC} V_c [1 + m_a \cos \omega_m t_0] \quad \text{--- (8)} \end{aligned}$$

To avoid clipping,

Slope of capacitor voltage \leq Slope of envelope voltage

$$\left. \frac{dV_c}{dt} \right|_{t=t_0} \leq \left. \frac{dV}{dt} \right|_{t=t_0}$$

$$-\frac{1}{RC} V_c [1 + m_a \cos \omega_m t_0] \leq -V_c \omega_m m_a \sin \omega_m t_0$$

$$\therefore \frac{V_c}{RC} [1 + m_a \cos \omega_m t_0] \geq V_c \omega_m m_a \sin \omega_m t_0 \quad \text{--- (9)}$$

mathematically,

$$\frac{1}{RC} \geq \omega_m \frac{m_a \sin \omega_m t_0}{1 + m_a \cos \omega_m t_0} \quad \text{--- (10)}$$

(49)

The value of time constant R_c is if the quantity

$\frac{m_a \sin \omega_m t_o}{1 + m_a \cos \omega_m t_o}$ is maximum.

This condition will be attained when the derivative of the quantity equals to zero.

$$\frac{d}{dt} \left[\frac{m_a \sin \omega_m t_o}{1 + m_a \cos \omega_m t_o} \right] = 0 \quad \text{--- (11)}$$

$$\cos \omega_m t_o = -m_a$$

(or) $\sin \omega_m t_o = \sqrt{1 - m_a^2}$

Hence Eqn (10) becomes.

$$\frac{1}{R_c} \geq \omega_m m_a \frac{\sqrt{1 - m_a^2}}{1 + m_a(-m_a)}$$

$\frac{1}{R_c} \geq \omega_m \cdot \frac{m_a}{\sqrt{1 - m_a^2}}$

 --- (12)

If m_a increases, ratio $\frac{m_a}{\sqrt{1 - m_a^2}}$ also increases. Hence when m_a approaches 100%, $\frac{m_a}{\sqrt{1 - m_a^2}}$ approaches infinity, and the

required time constant approaches zero. This analysis is for attaining no clipping condition. The maximum value of time constant R_c must be selected in accordance with the relation.

$\frac{1}{R_c} \geq \omega_m m_a$

Distortion in linear diode detector

Distortion is mainly due to the following factors

(i) Improper selection of time constant RC.

→ RC too low:

- * Removal of radio frequency component is inadequate
- * Output voltage waveform is spiky in nature.

→ RC too large:

- * clipping results during the negative peaks of the modulation wave.

(ii) Curvature of diode characteristics:

Efficiency of rectification varies according to the amplitude of the envelope. It can be reduced by

- * selecting value of $R_L > R_A$
- * selecting larger amplitude carrier wave.

R_L → Load Resistance

R_A → Anode Resistance.

Types of AM System

- i) DSBSC (Double side band Suppressed carrier)
- ii) SSBSC (Single side band Suppressed carrier)
- iii) VSB (Vestigial Side band Modulation)

DSB-SC SYSTEM

Why carrier Suppressed?

- * Carrier component remains constant in amplitude and frequency.
- * Carrier does not convey any information.
- * In power calculation, above 67% of total power is required for transmitting the carrier.
- * Suppression of carrier does not affect the baseband signal.

In DSB-SC system, the carrier is suppressed from the modulated wave and ^{only} the sidebands are present.

Spectrum of DSB-SC Wave (Mathematical Analysis)

$$x(t) \longleftrightarrow X(\omega)$$

$$e^{j\omega_c t} x(t) \longleftrightarrow X(\omega - \omega_c)$$

$$e^{-j\omega_c t} x(t) \longleftrightarrow X(\omega + \omega_c)$$

$$\begin{aligned} x(t) \cos \omega_c t &= x(t) \frac{1}{2} [e^{j\omega_c t} + e^{-j\omega_c t}] \\ &= \frac{1}{2} x(t) e^{j\omega_c t} + \frac{1}{2} x(t) e^{-j\omega_c t} \end{aligned}$$

By frequency shifting property.

$$x(t) \cos \omega_c t \longleftrightarrow \frac{1}{2} [X(\omega - \omega_c) + X(\omega + \omega_c)]$$

$x(t)$ → Modulating signal

$\cos \omega_c t$ → Carrier signal

$x(t) \cos \omega_c t$ → Modulated signal. [DSB-SC signal]